

# RADIO AMATEUR NEWS

REG. U.S. PAT. OFF.

20 Cents  
FEBRUARY  
1920  
OVER 100  
ILLUSTRATIONS  
Edited by  
*H. Gernsback*

"The 100% Wireless Magazine"

## THE RADIO COMPASS

SEE PAGE 398

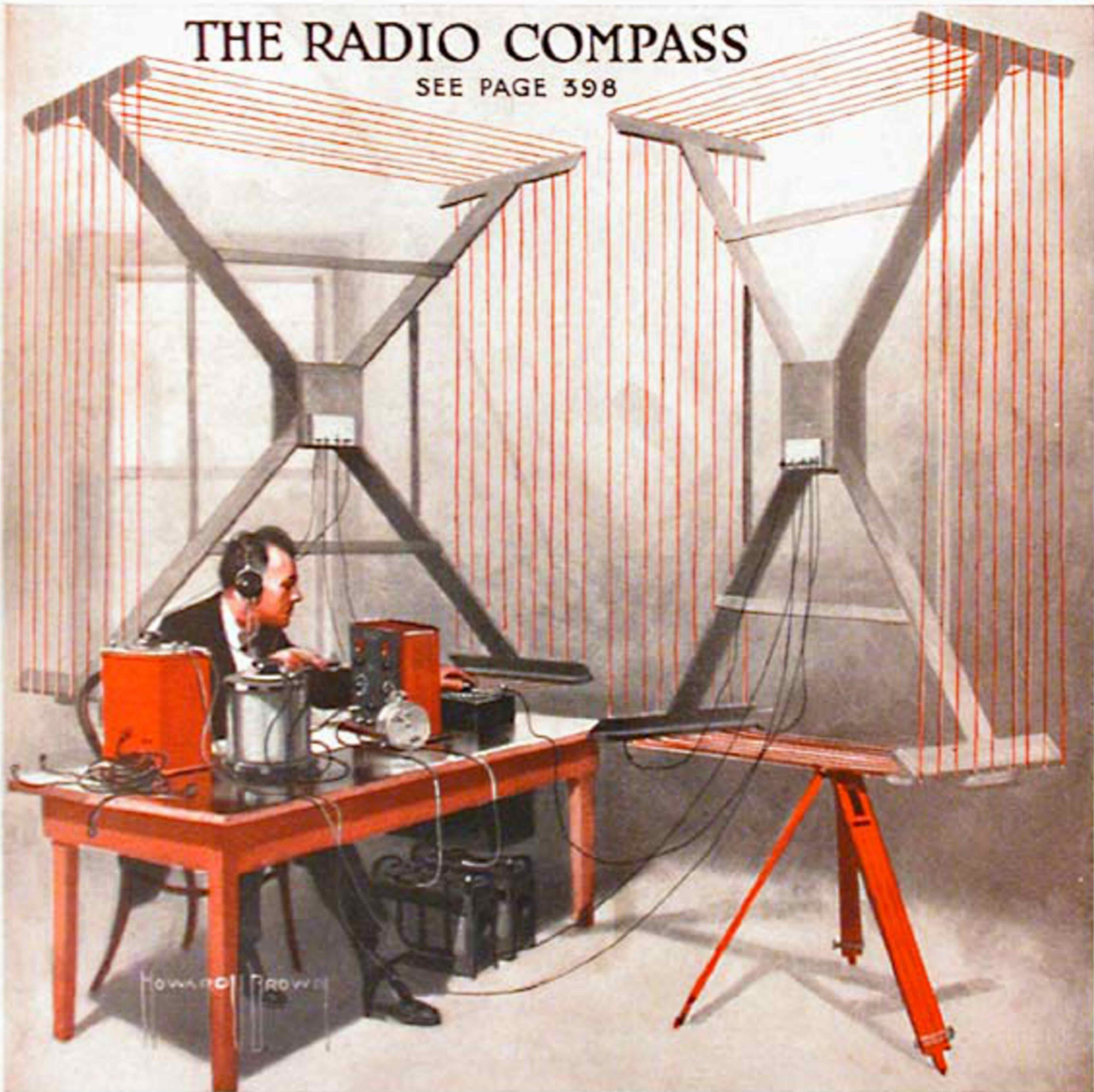

In This  
Issue:

The Armstrong Super-Autodyne Amplifier  
By H. W. Houck, A. I. R. E.  
A Modified Government Receptor  
By J. Stanley Brown

A New Receiving System  
By E. T. Jones  
The Radio Compass  
By J. H. Dellinger, Ph.D., Bureau of Standards

"ASK ANYONE WHO HAS USED IT"

**"Light and Sensitive. The Mechanical Construction Is Good, and They Look Very Neat."** (Name on Request)

This extract from the letter of a satisfied patron is in line with what they all say.

**BRANDES  
WIRELESS  
HEADSET**



**CLEAR TONE  
LIGHT WEIGHT  
DEPENDABLE SERVICE**

Superior Type  
2000 ohms, \$7

Transatlantic Type  
\$10

Navy Type  
\$14

Score 100% efficiency in actual use. Sharp, Unblurred, Readable Signals assured by

**"BRANDES MATCHED TONE"—**

Exactly matching the tone of both receivers in each set and thus eliminating all confusion due to unmatched harmonics.

**TRIAL  
OFFER**

Buy a Brandes Superior Headset and use it critically for ten days. Then, if it doesn't come up to our claims or your expectations, return it and your money will be cheerfully refunded. Test it—compare it with others—for sensitiveness, clearness, distance. Prove for yourself the fine quality, the "matched tone." The two diaphragms, toned exactly alike, strengthen the signals and prevent blurring. Used by many U. S. Government experts, and experts abroad; by colleges and technical schools; and by professionals and amateurs everywhere.

SEND 4c FOR CATALOGUE "C"

C. BRANDES, Inc., Room 823 32 Union Square, New York, U. S. A.  
WIRELESS RECEIVER SPECIALISTS

**DE FOREST**

## The Easiest Way to Get a Radio Receiving Station

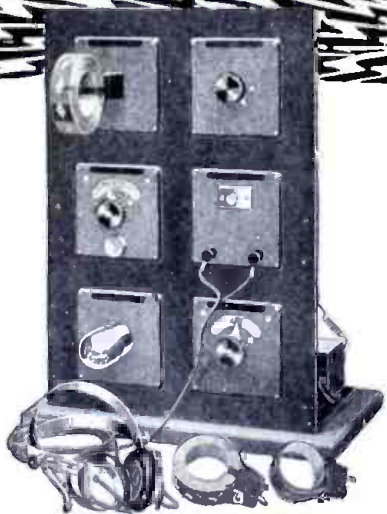

### De Forest Audion-Unit Radio Receiving Station

(6-panel set illustrated above)

A larger and wider range Set with Audion Detector and large assortment of "Honey-Comb" Coils, giving wider receptive facilities. 6-panels in all, with all necessary apparatus and supplies, including "B" Battery. Arranged for expansion when the owner desires.

Send for our new booklet, "How to Set Up and Operate an Amateur Radio Receiving Station," which tells all about these new Sets. Send postpaid for 10 cents in stamps.

**DE FOREST RADIO TELEPHONE and TELEGRAPH CO.**

Inventors and Manufacturers of Amateur and Commercial Radio Apparatus  
1401 SEDGWICK AVENUE NEW YORK CITY

**DE FOREST**



### De Forest Simplified Radio Receiving Station

(3-panel set illustrated at right)

Also complete in every detail, including short, medium and long wave-length deForest "Honey-Comb" Coils, Detector, Condenser, Head Telephones, Antennae Wire—everything needed to set up and operate an efficient Receiving Station. Complete instructions for assembling and operating included

You benefit by mentioning the "Radio Amateur News" when writing to advertisers.

# TRIODE

(TRADE MARK)

## Audio Transformer Type P

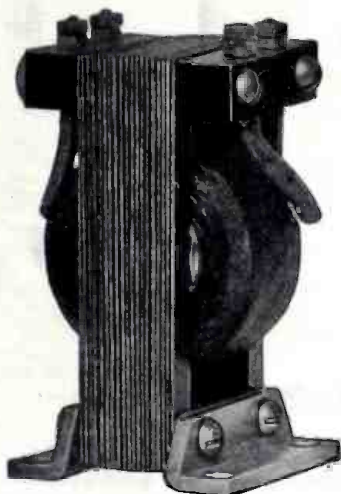

PRICE \$7.00  
Postpaid  
**IMMEDIATE  
DELIVERY**

Standard Vacuum  
Tubes \$7.00 each.

Due to its operation on the principle of voltage amplification through resonance this transformer provides a maximum of low frequency amplification and is superior to all others. Permits reliable daylight reception from European stations. Establishes new amateur long distance records. Renders remarkable amplification of all signals. May be used with the Marconi and all standard tubes.

# TRIODE

(TRADE MARK)

## Vacuum Tube Socket Type F



Price \$1.25 Postpaid

The base of this socket is bakelite dielecto and will not crack and break like the moulded material of the usual socket. Contact springs are stamped with identifying letters. Base is provided with three rubber feet and four countersunk holes for panel mounting.

We also manufacture:

Eaton Oscillators                      Two Step Amplifiers  
Grid Leaks                                  Damped and Undamped Receivers  
**FARADON MICA TRANSMITTING CONDENSERS**  
Standard and Special Radio  
Equipment of Every Description

~~~~~

**Wireless Specialty Apparatus Co.,** ENGINEERS, DESIGNERS, MANUFACTURERS  
BOSTON, MASS., U. S. A.



Panel Receiving Set

## BULLETIN Y and Z

will be mailed for 4c stamp and describe in detail a product which has been famous for its reliability during twelve years of successful manufacture. All good dealers carry CLAPP-EASTHAM apparatus in stock and recommend it.

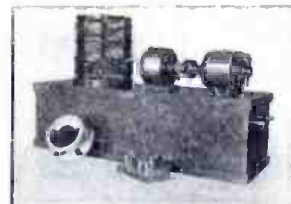

½ k. w. Hytone Transmitting Set

We believe our line to be the most complete made by any one manufacturer, including—

- High Tension Transformers
- High Tension Condensers
- Spark Gaps
- Antenna Switches
- Keys
- Meters
- Tesla Coils
- Electrolytic Interrupters
- Complete Sets
- Variometers and Tuners

- Variable Air Condensers
- Buzzers
- Wave Meters
- Detectors and Tubes
- Amplifiers and Amp. Coils
- Telephones
- Oscillation Transformers
- Variable Laboratory Inductances
- Parts and Materials

**CLAPP-EASTHAM COMPANY,** 120 Main Street  
CAMBRIDGE MASS.

*You benefit by mentioning the "Radio Amateur News" when writing to advertisers.*



Fleming Pat. No. 803684  
De Forest Pat. Nos. 841387-879532

# A WARNING

to Manufacturers  
Importers  
Dealers  
Jobbers  
Agents  
Amateurs  
Purchasers  
Users of

## Vacuum Tubes The Marconi V. T. Patent is Basic

United States Letters Patent to Fleming, No. 803,684, November 7, 1905, has been held to be valid by Judge Mayer of the United States District Court for the Southern District of New York, and by the United States Circuit Court of Appeals for the Second Circuit.

It is a basic patent and controls broadly all vacuum tubes used as detectors, amplifiers or oscillations in radio work.

No one is authorized to make, sell, import or use such tubes for radio purposes, other than the owners of the patent and licensees thereunder. Any others making, selling, importing or using them alone or in combination with other devices, infringe upon the Fleming patent and are liable to a suit for injunction, damages and profits. And they will be prosecuted.

### THE AUDIOTRON AND THE LIBERTY VALVE ARE NOT LICENSED UNDER THE FLEMING PATENT

The price of the genuine Marconi V. T. delivered is \$7.00 each. The standardized socket is \$1.50 additional. The standard resistance, complete, costs \$1.00 and is made in the following sizes:  $\frac{1}{2}$  megohm, 1 megohm, 2 megohms, 4 megohms, 6 megohms.

Do not take chances by making, importing, selling, purchasing or using vacuum tubes for radio purposes not licensed under the Fleming patent. By selling, purchasing or using licensed tubes for radio purposes you secure protection under the Fleming patent and avoid the risk of litigation for infringement thereof.

This warning is given so that the trade and public may know the facts and be governed accordingly.

*Send all remittances with order to* **COMMERCIAL DEPARTMENT**

**MARCONI WIRELESS TELEGRAPH CO. OF AMERICA**  
**RADIO CORPORATION OF AMERICA**  
225 Broadway      Woolworth Building      New York

*Sole Distributors for De Forest Radio Telephone & Telegraph Co.*

Retail Office and Exhibition Rooms, 25 Elm St., New York

Schofield Bldg., Cleveland, Ohio  
American Bldg., Baltimore, Md.

Insurance Exch. Bldg., San Francisco, Cal.  
136 Federal St., Boston, Mass.

301 Commercial Bank Annex, New Orleans, La.  
109 South 2nd St., Philadelphia, Pa.



# RADIO AMATEUR NEWS

H. GERNSBACK — EDITOR

Vol. 1.

FEBRUARY, 1920

No. 8

## Interplanetarian Wireless

ONCE again interplanetarian radio has come to the foreground. For the past few weeks the press has been full with all sorts of talk about radio from Mars and radio from Venus. Even the poor old moon has not escaped.

Signor Marconi recently announced from London: "We occasionally get very queer sounds and indications, which might come from somewhere outside the earth. We have had them both in England and in America. The Morse signal letters occur with much greater frequency than others, but we have never yet picked up anything that could be translated into a definite message. The fact that the signals have occurred simultaneously at New York and London with identical intensity seems to indicate that they must have originated at a very great distance. We have not yet the slightest proof of their origin. They are sounds. They may be signals. We do not know. They are not static and we have nothing to guide us at present as to how the signals are caused.

"We do not get them unless we set up a special wave length, very much greater than the wave length ordinarily used. Sometimes there may be a long wait before we hear anything, or we may hear these sounds in twenty minutes or half an hour. They occur when we are using a wave length of approximately 100 kilometers, which is three or four times the length used for commercial purposes.

"They might conceivably be due to some natural disturbance at a great distance, for instance, an eruption of the sun causing electrical disturbances."

Asked whether attempts were possibly being made by another planet to communicate, Signor Marconi said:

"I would not rule out the possibility of this, but there is no proof. We must investigate the matter much more thoroly before we venture upon a definite explanation."

He added that the mysterious sounds are not confined to any particular diurnal period. "They are equally frequent by day and night," he said.

Since Marconi made this announcement a great controversy has raged among scientists and would-be scientists. Many interesting things have been printed among the wagon-loads of pure rubbish, that convulse one with its unintentional humor.

Scientists, as a rule, are the most one-sided folk on the face of the globe. It is seldom that you find an expert on astronomy who is at the same time an expert on radio or in physics.

To give but one ludicrous example. Let us only quote Professor Harold Jacoby, the eminent head of the Department of Astronomy of Columbia University of New York. Says the Professor:

"It is highly improbable that the people of another planet, if there are any such, would be acquainted with the Morse code, which is a complicated system of dashes and dots based on our alphabet. It was invented by Morse and cannot be regarded as universal among civilized peoples.

"If the people of another planet were seeking to signal us they would probably select a system of signals which would be understood on any planet where civilization exists. Such a system would much more probably be based upon numbers than upon letters of the alphabet, for the people of different planets would be no more likely to have the same alphabet than different peoples here on earth are to have the same language."

The italics are ours. Evidently the worthy Professor imagines that the Martians would drop wooden or steel numbers over our aerials. We might ask WHAT else the Martians could use besides dots and dashes. A radio telegraph message cannot by any conceivable means be made up of any other code except either dots or either dashes, or else a combination of the two. The dots and dashes may be high or low buzzes, whistlings, flute-like tones or any other form of sound, BUT there must be dots or dashes or both. There is only one alternative, and that is the voice.—Radio Telephony in other words. We will return to this later.

Other eminent scientists such as Dr. Greenleaf W. Pickard, John Hays Hammond, Jr., Professor Svante Arrhenius of the Chair of

Physics of the Stockholm Technical Institute, seem to think that the mysterious signals are caused by the sun. So thinks Dr. Charles P. Steinmetz, adding that interplanetarian wireless "must be regarded as a wild dream."

Other eminent scientists such as Nikola Tesla, Thomas A. Edison, and of course Marconi think it not impossible that the signals are coming from some planet such as Mars or Venus. Indeed the believers in this theory are far more numerous than the unbelievers.

In his former editorials, the writer has often dwelled upon interplanetarian communication, and he is of the firm opinion that if communication is ever established between the earth and the outside world, it will of course be by the agency of Radio.

Let us now analyze the situation and draw a logical conclusion from the facts on hand.

The most important fact—entirely overlooked by the press, and all would-be scientists—is found in that one line of Marconi's statement:

"The signals occur at a wavelength of approximately 100 kilometers."

That is a fact of tremendous importance.

When radio first was invented some twenty odd years ago, we used but trifling wave lengths from less than 500 meters upward. It was soon found out that to bridge great distances, such as sending across the ocean and further, much longer wave-lengths were absolutely necessary. In other words, the greater the distance we wish to cover, the greater the wave-length we require. Thus today our great transoceanic radio stations operate on wave-lengths from 6,000 to 16,000 meters (6 to 16 kilometers). This gives an average of about 10,000 meters.

Let us now assume that the average distance these stations cover is 5,000 miles. That gives us 2,000 meters wave-length for every 1,000 miles we cover.

If now one of our radio engineers were to build a station that could transmit from the earth to Mars—a distance ranging from 60 million miles down to 35 million miles during opposition—he would certainly adapt his wavelength to the distance. A simple calculation—based upon terrestrial standards—reveals then that the necessary wavelength would be at least 30,000 kilometers, an unheard of figure compared to our 6 or 12 kilometer pigmy wave-lengths.

But we must not forget that the human mind is unused to apply his terrestrial yardstick to celestial distances.

Our conclusion must then be that if any extra-terrestrial messages are picked up by us they will be received on wavelengths at least above 20,000 kilometers. This would make Marconi's 100 kilometers look quite sick!

Here then is a chance for our earnest investigator to get busy at once. Tuning coils or concentrated inductances to tune up to 30,000 kilometers (30,000,000 meters) can be assembled for less than \$100 today, if used in connection with a very large aerial. If there are any extra-terrestrial messages, I predict quick confirmation of them.

On the other hand, the intelligent creatures who know how to send radio messages across a chasm of 50 million miles, admittedly know a few things about the game themselves. They may have sent these messages for centuries upon centuries, waiting for us to grow up and finally hear them. Thus the Martians and probably the Venerians are surely on an infinitely higher plane of civilization than ourselves. And we with our twenty odd years' experience in radio—don't we really look foolish in the extreme?

But to make the point clear, if we do get messages, they probably will not all be in dots and dashes. They may come in musical notes, the same as we transmit radio band music from a phonograph over hundreds of miles, or they may come in the actual voice (providing these beings talk like we do), in other words, radio telephone messages. But time will tell. In the meanwhile we shall wait a bit longer.

H. GERNSBACK

# Radiophone Communication to and from Trains

By J. J. GRAF\*

**T**HE successful accomplishment of wireless telegraph communication to and from trains on the Lackawanna Railroad, previous to the time, when all but government operated stations were dismantled in 1917, is generally known. The Lackawanna proved that

lack of enthusiasm. We had met with very obdurate obstacles with overland wireless telegraphy. When the Lackawanna began its trials with wireless communication some doubt existed as to the possibility of using the rails for grounding the electrical current. A ground wire was easy to place

come in a similar way. We now felt that since both were now functioning satisfactorily, Mr. Foley should feel satisfied. However, he was determined that the telephone should be substituted, saying that the situation was no different from the wire situation and since the telephone had

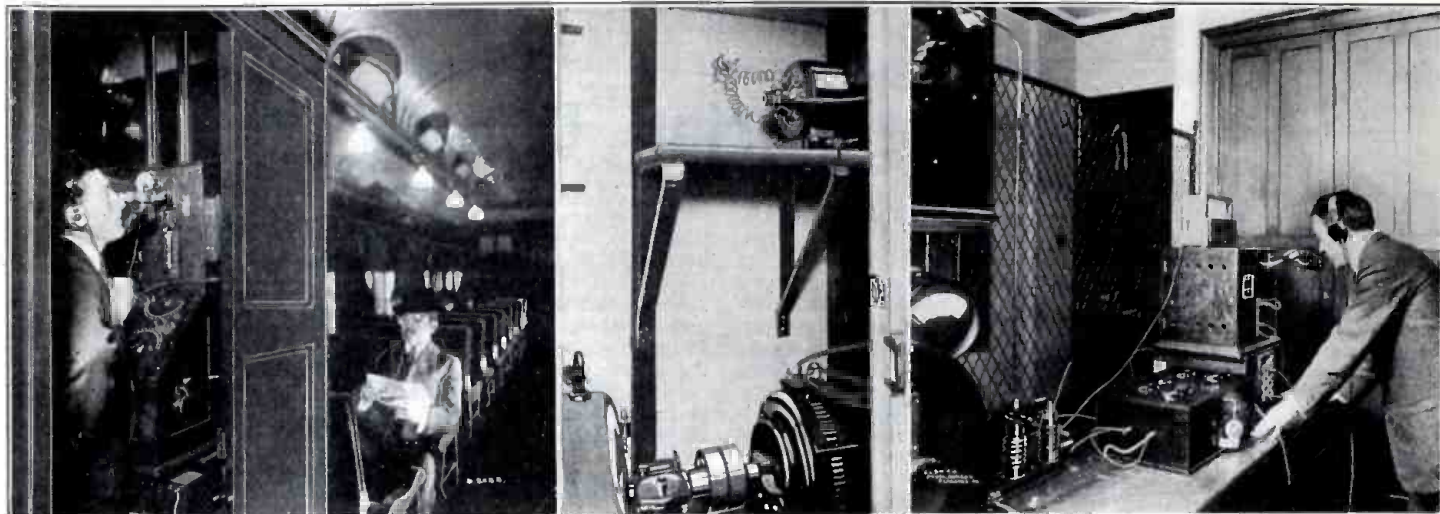

In the Photograph at the Left Mr. Logwood of the De Forest Radio Telegraph Company Is Carrying on a Radiophone Conversation with the Railroad Station Far Away. It is Now an Easy Matter for the Passenger to Keep in Touch with His Office While on a trip to the Mountains. In the Center is Shown the Turbine Generator Set, Used to Furnish the Power for Operating the Radiophone. To the Right is Shown the Radio Station at the Depot. The Operator Here is Communicating with the Distant Train, When Other Means of Communication Proved Unsuccessful.

wireless service for ordinary operating purposes was entirely practicable. It proved this when the regular wire communications were cut off by storms by handling train orders as accurately and reliably as they had been handled on the land lines. On one occasion such a storm had crippled wire communication for a radius of about 200 miles west of New York, and the New York Central could obtain no information as to the whereabouts of its Twentieth Century Limited.

The train was lost in the storm, but its whereabouts was finally revealed to the people waiting at the terminal in New York by means of the Radio Telegraph.

During another sleet storm telephone and telegraph lines were put out of commission in the mountain division of the Lackawanna, and the train orders were handled without difficulty between Scranton and Binghamton by wireless.

The progress made with the wireless telephone was not generally divulged because our results had far from attained the goal designated by Mr. L. B. Foley, Telegraph Superintendent and directly in charge of this work.

As a matter of fact we had taken up this work with perhaps a perceptible

at every wireless station, but "hooking up" a moving train in the same way was a different thing. So the scheme was adopted of sending the ground current to the rails, and it worked with entire success.

Another early problem was whether using that electrical current supplied by the dynamos on the trains would not dim the lights in the coaches, but this, too, was solved without interfering with the comfort of passengers.

Several other such difficulties were over-

supplanted the telegraph for the dispatching of trains and general railroad work; with acknowledged greater efficiency, it followed that Radio telegraphy must necessarily also be discarded.

We searched all available data as to the progress made in telephone transmission and decided that Dr. Lee DeForest had so far achieved the greatest practical results. Mr. Foley prevailed upon the Doctor to interest himself in the venture and with the energetic assistance of his Chief Engineer, Mr. Charles Logwood, the initial apparatus was soon assembled.

Experiments soon developed that the necessary power to maintain a generator speed of 4000 revolutions, was not available from the car-lighting battery when the train was standing still or from the axle generator when under way. We finally decided to make up a generator set with a Sperry steam turbine directly connected to Dr. De Forest's 3000-cycle generator. We housed this machine in a small room partitioned off in the baggage car and installed a two-inch steam line to the boiler of the engine, using a specially built, reinforced, flexible coupling between the car and tank. With this arrangement we had no difficulty maintaining current at 6

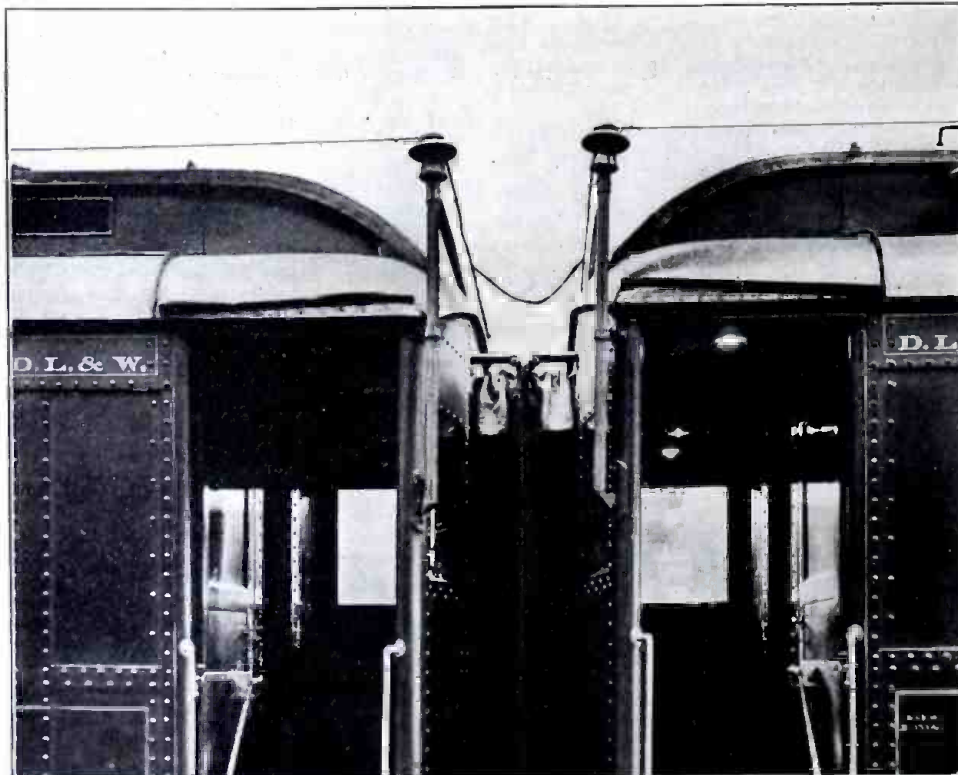

The Problem of Erecting an Antenna Which Would Still Enable the Train to Pass Under Low Bridges Was Solved as Shown. By Having Three or Four Cars Equipped in This Manner an Antenna of Considerable Size Was Formed.

\*Telephone Engineer of the D., L. & W. R. R.

amperes, 150 volts and the frequency mentioned. A small 24-volt generator was belted to the combination set shaft to provide the necessary exciting current.

De Forest designed and built two special telephone outfits which were entirely self-contained. A three-point tungsten arc was mounted exposed and was the only part of the apparatus ever requiring adjustment after the original settings had accomplished continuity of oscillations and proper wave length, which from the train was 800 meters and from the Scranton, Pa. station, 1200 meters. In general appearance and operation, the instruments looked like an old fashioned Gray pay station and operated similar to an ordinary telephone, except that it was necessary to keep a button depressed to disconnect the shunt across the transmitters when speaking. When the conversation was finished the action of hanging up the receivers, operated a solenoid-controlled valve in the bagged car and shut off the steam supply.

The antenna arrangement used was as follows: On top of each car was an aerial consisting of a quadrangular closed loop, supported at each corner by insulators on iron pipes at the corners of the car. The aerial was raised only about eighteen inches

above the roof of the car, this being the maximum space allowable so as to clear tunnels and bridges.

On the Lackawanna Limited four coaches were thus equipped, the connection between them being made by a plug and socket, the arrangement being flexible so as to accommodate itself to the movement of the train. The aerial on the roof of each car was about sixty-five feet long and was composed of twisted bronze wires.

It was some time prior to this date that Dr. DeForest discovered that the audion valve would modulate direct current of considerable potential and transform it to unlimited but controllable frequencies. Experiments of this discovery were developing in connection with our system but made no progress because of the action of the government, already mentioned. Within a few months however, radio engineers of the American Tel. & Tel. Co., and Western Electric Co., acting in conjunction with the Navy Department, carried on the famous conversations between the Arlington, Va. and Eifel Tower, Paris stations, using audions to control the transmission current.

Our own experiments at the time the stations were closed had resulted in a de-

pendable range of 60 miles, all wireless. We had also accomplished transformer connection with our regular telephone system, which enabled the person talking from the train to be switched to any telephone and no difficulty was experienced in hearing the person on the train; in fact, it is conceded that wireless enunciation is much clearer than that on the wire phone. The person at the regular instrument, however, could not speak direct to the person on the train, so his conversation was repeated by the attendant of the wireless station at Scranton.

We were working in this direction because Mr. Foley contemplated that in addition to using these facilities to handle regular traffic and operating business, passengers traveling over the Lackawanna should be able to converse directly with their office or homes and the fact that they were en route would in no way deprive them of the convenience of ordinary telephone service. This was an unreasonable expectation before the war but is today actually being done from our vessels at sea and the writer has no doubt that in the very near future, telephone connection to and from moving trains will be common place practice.

## Device to Supplant News Tickers

By GUGLIELMO MARCONI

Notwithstanding that the transmission of electric force by wireless radiation is already one of the indispensable factors in the world's social and commercial economy, the science of wireless transmission is yet in its infancy. The marvels which remain to be achieved in the field of electric radiation pass the compass of the human imagination.

During the past five years of war, little apparent progress was made, so far as the layman is concerned, in the development of commercial wireless. The layman, however, is totally unaware of what has been going on behind the scenes in the wireless world since 1914, for the reason that all new inventions have been commandeered by the various belligerent governments and held scrupulously secret for fear improvement might be seized upon by enemy interests to further military plans.

### SMALL BUT MARVELOUS.

I have in my home, for instance, a marvelous little contrivance, no bigger than the ordinary phonograph, which is a self-contained wireless receiving set, so accurate and so sensitive that, without a single exterior or other solid communication with the outer atmosphere it registers for me the entire important wireless activity of the world and brings into my own sitting room the wireless press news of all Europe.

With an instrument similar to this bankers, brokers and business men generally will be able to keep in touch with the entire world's activity from minute to minute.

The conventional news ticker, upon which all newspaper offices are dependent to-day will shortly be supplemented by this powerful adjunct to news transmission, which permits a single

operator at the sending point to communicate with an indefinite number of receiving stations simultaneously, thus cutting down the tremendous expense and loss of time entailed in sending separate messages over as many wires as there are receiving points.

### EDUCATIONAL EFFECT.

It is difficult to conceive of the tremendous educational effect of this appliance along when its possibilities are fully developed, as they will be very shortly, to such a point that, in conjunction with an automatic ticker, the day's news from the four corners of the earth will be registered in clear language without the necessity of a Morse code expert to handle the receiving end.

With such a wireless receiving set installed in every public school, university and library throughout the civilized world, the average interest in public and international affairs will be tremendously augmented and there will no longer be any reason why the school boy and girl should not

be as well informed in matters of current importance and at no expense, as the most inveterate newspaper reader.

The war contributed a notable impulse to the development of wireless telephony. America was particularly forward in this field and succeeded, through the genius of its inventors and experts, in producing a really practical apparatus for the transmission of the human voice over considerable distances by means of wireless electric waves.

### CHINA USES RADIOPHONE.

It is a curious fact that while the most progressive nations of the western hemisphere have not adopted the wireless telephone on a commercial basis and are still experimenting on possible improvements, China, most backward of all the great nations, is making current use of the wireless telephone as a means of communication between outlying towns and villages which have not as yet been connected with the ordinary telephone system.

Within 50 years wireless voice communication will in all likelihood supplant the present cumbersome system and materially cut down the expense of wire laying and upkeep and the inconvenience of broken communication which today isolates whole regions every winter following the damage wrought by rain and sleet.

In the past five years of military secrecy we have been making progress in the problem of directing wireless energy. Hitherto electric energy transmitted through the air has spread out with equal intensity in all directions, thus dispensing the total force employed over a vast area and limiting the distances at which communication was possible.

### REACHING FARTHER.

Today we are able to concentrate the energy expended to a limited sector (Continued on page 437)



Behold the "Radioauticker". No Longer Does Mr. Banker Have to Stick Around the Office for Taps News. In the Auto, at His Home, on a Train—In Fact, Anywhere He Can Keep in Touch with the World's Activity.

# The Radio Compass

By J. H. DELLINGER

Physicist in the Bureau of Standards.



The Engineer Is Shown Here Making Measurements of Constants of a Coil Antenna at the Bureau of Standards. No Doubt Many of Us Would Be Delighted To Work In an Open Air Laboratory of This Sort.

**N**OTHING is more certain than that space will be completely annihilated, and any two persons anywhere will be able to talk to each other. The instrument used will be the ordinary telephone now in our homes. Whether a person is on an airplane, under or on the ocean, or in a desert or mountain place where wires cannot be run, he will be able to talk with anyone he wishes. The means of doing all this are now in the hands of our scientists. This is one of the undeniable gains that has issued from the intense development of radio communication during the war.

#### MOBILIZATION OF MEN OF SCIENCE FOR WAR WORK.

A few glimpses of the work which Uncle Sam's great scientific laboratory was concerned with during the war may be the best approach to an understanding of the kind of radio work which the Government does. At the beginning of the war America was far behind other countries in the application of the most advanced knowledge to warfare. In the sudden necessity of fashioning the instruments of war science led the way. An interesting story might be written of the mobilization of the scientists in the early part of the war. Groups of scientists were exchanged between France, England, and America; scientific attachés were added to the military and naval attachés at the embassies in London, Paris, and Rome.

The most notable of the scientific groups which visited America was the French Scientific Mission, which came early in 1917 immediately after we entered the war. In this group was Prof. Henri Abraham, of the University of Paris, who has been the leader in applying electrical science to radio apparatus for war purposes. This Mission brought a large quantity of scientific appa-

ratus, which was set up and demonstrated to Army and Navy officers and selected scientists at the Bureau of Standards in Washington. A false impression has existed in the minds of many people that scientific devices used in warfare are principally deadly or horrible instruments. Thus it was rumored that the French mission brought with them poisoned bullets and other diabolical devices. As a matter of fact, the nearest to anything of this sort which was brought was a bomb-dropping mechanism which, after all, was purely a

sort of mechanical trigger for releasing a bomb from an airplane. This does not mean that science escapes guilt in the destruction of enemy peoples. A simple radio transmitter on an airplane may transmit the range of an enemy position, and an instant later a hundred men be slaughtered by a gun ten miles away. Without scientific instruments this destruction would be impossible. Certainly it is not only the man who pulls a trigger or jabs a bayonet who is responsible for dealing death to the enemy. It is a fact that the collapse of Germany was due, in large part, to the superiority of allied science. This should settle forever the fallacy often stated and widely believed, that Germany led the world in science. It has been known for years among scientific men that this was not true, and mankind has much to be thankful for that French, American, and other scientists were not behind the Germans.

#### THE PART PLAYED BY RADIO IN MODERN WARFARE.

The absolute necessity of radio in modern warfare is apparent when one considers the tremendous complexity of the fighting methods. The use of artillery is not at all the mere pulling of a trigger by a man who looks at his target; the use of big guns involves not only the properties of gunpowder and the use of ballistics, but also depends on aviation, radio, meteorology, map-making, and many other sciences and arts. The gunner does not see the object of his shot nor does he see even the airplane which is watching the mark and telegraphing results of his shots to him. All methods of conveying signals are used, from the most primitive to the most advanced, from the use of a human courier to the use of electric waves. Radio has been used not only to give orders, direct battle, and listen to the communications of the enemy, but also for purposes so widely diverse as the issuing of propaganda, the conduct of armistice negotiations, and the saving of ships at sea. In the several allied countries large laboratories were established for the investigation of radio waves and for the development of apparatus which would utilize them in the most efficient manner. Existing scientific laboratories were utilized for research on the



The Arrangement Here Shown Is a Simple Short-Wave Generating Set Using a Small Vacuum Tube.



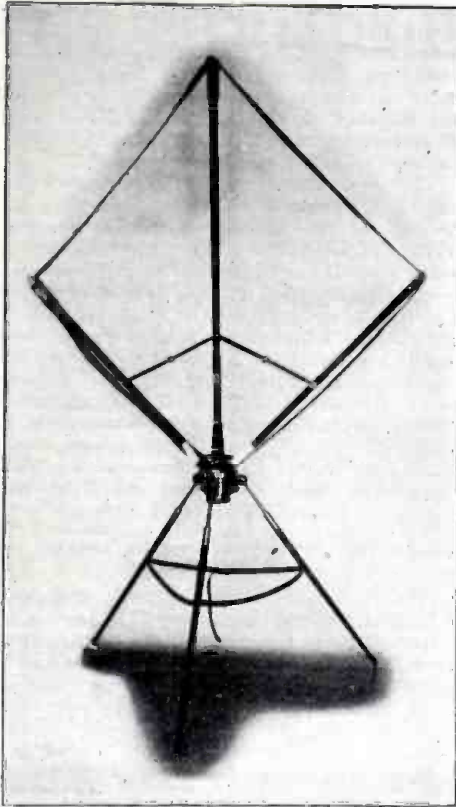

A Portable Collapsible Direction Finder Used During the War for Transmission as Well as Reception.

more fundamental principles and instruments, and the military services established special laboratories of their own to design the military equipment.

**BIG PROBLEMS TO BE SOLVED WHEN WAR CAME.**

When this country entered the war, the Bureau of Standards was ready with methods, apparatus, and trained personnel for the solution of many of the fundamental problems which confronted military men. Among the problems which had to be solved, and solved quickly, were: (a) The establishment of high-power transoceanic radio systems for use in case all the cables should be cut; (b) the development of low-power radio equipments which should send out just enough but not too much power to communicate in the congested area of any given sector at the front; (c) the location of enemy radio stations and airplanes, submarines, and ships; (d) communication with and from submarines, particularly when totally submerged; (e) the production of radio apparatus which could be easily carried and yet comprise everything necessary to make the most effective use of radio waves; (f) the training of great numbers of men in a complex and rapidly changing subject.

**IMPORTANCE OF ELECTRON TUBE AND DIRECTION FINDER.**

Fortunately, certain radio devices existed which gave promise of solving a number of the more important problems. Among the most noteworthy of these devices are the electron tube and the direction finder. The first of these, the electron tube, is a device which makes possible radio telephony. The direction finder is a simple apparatus which not only receives the radio waves but which can also be turned in such a way as to determine the direction from which the waves come. While these devices were known they were imperfect, their principles were only slightly understood; yet both scientists and military engineers saw in them the promise of great utility and the solution of problems which would give our army great superiority over the enemy. Much has been done in the application of

the best scientific knowledge to the development of these instruments.

The direction finder now used is ridiculously simple. It is nothing more than a coil of a few turns of wire. To this is attached detecting apparatus which converts the wave which falls on the direction finder into a sound that is heard in a telephone receiver. The direction finder receives the wave in the same way as the more familiar antenna, which is seen in connection with most radio stations. It is a much smaller structure, being in fact usually only about 4 feet by 4 feet in size. It is not as powerful a receiver of the radio waves, but its great advantage is that it determines the direction. The wave produces electrical action in the coil only when it is placed in the line of the advancing wave. If it is rotated so that it lies across the line of the wave, no effect is produced. As one turns the coil the received signal changes from a certain maximum loudness to a weaker and weaker and finally zero sound. From the position of the coil, when the sound is thus reduced to zero, one easily determines the line of direction of the wave. In brief, one may say that the current circulates around the coil instead of oscillating up and down as in an antenna. This simple apparatus was in constant use to locate the position of enemy radio outfits in the trenches, on ships, in the air, and under the ocean, with the result that many were destroyed.

**THE REMARKABLE DEVELOPMENT OF THE DIRECTION FINDER.**

What were the scientific problems in the development of the direction finder? In the first place it was necessary to determine

how accurately the direction could be found. Was this accuracy sufficient to make it possible to aim a gun so as to destroy the transmitting station? Was it sufficient to replace the magnetic compass on a ship? (By the way, this use of the radio direction finder in navigation has led to the name generally adopted among naval and flying men, "the radiocompass.") Another important practical problem was the determination of the absolute direction of the transmitted wave. That is, could the direction finder determine not only the line of transmission of the wave but also from which of the two possible directions along that line the wave came? Other questions were: What was the best detecting ap-

paratus to use with this receiving device? How did it compare with an antenna of a given size in the receiving of weak signals? What could be done to replace the antenna with this simple coil aerial, not only for a receiving but as a means of transmitting radio waves?

Among the investigations at the Bureau of Standards, in consequence of these and similar practical questions, was a study of the relative advantages and applications of the coil aerial and the ordinary antenna as a radiator and receiver of radio waves. This was done both by experiments upon typical apparatus and by intensive study of the theoretical principles involved and the fundamental nature of radio waves themselves. It was found that surprising distances of communication could be attained by the coil aerial. By the use of exceedingly sensitive amplifiers as detecting devices with an aerial consisting merely of a few turns of wire located inside an ordinary room, signals transmitted from Germany were received in Washington. Not only that but the directions of the transmitting stations were accurately determined by the same apparatus.

The mathematical laws comparing the currents in either an antenna or a coil aerial were worked out. These laws pointed the way to improvement of the apparatus, indicating what design, kinds of communication, etc., were most useful for the various wavelengths used in radio communication. It should be understood that the radio waves are produced by very rapidly oscillating or alternating currents in a transmitting apparatus. The more rapidly the current alternates, the shorter

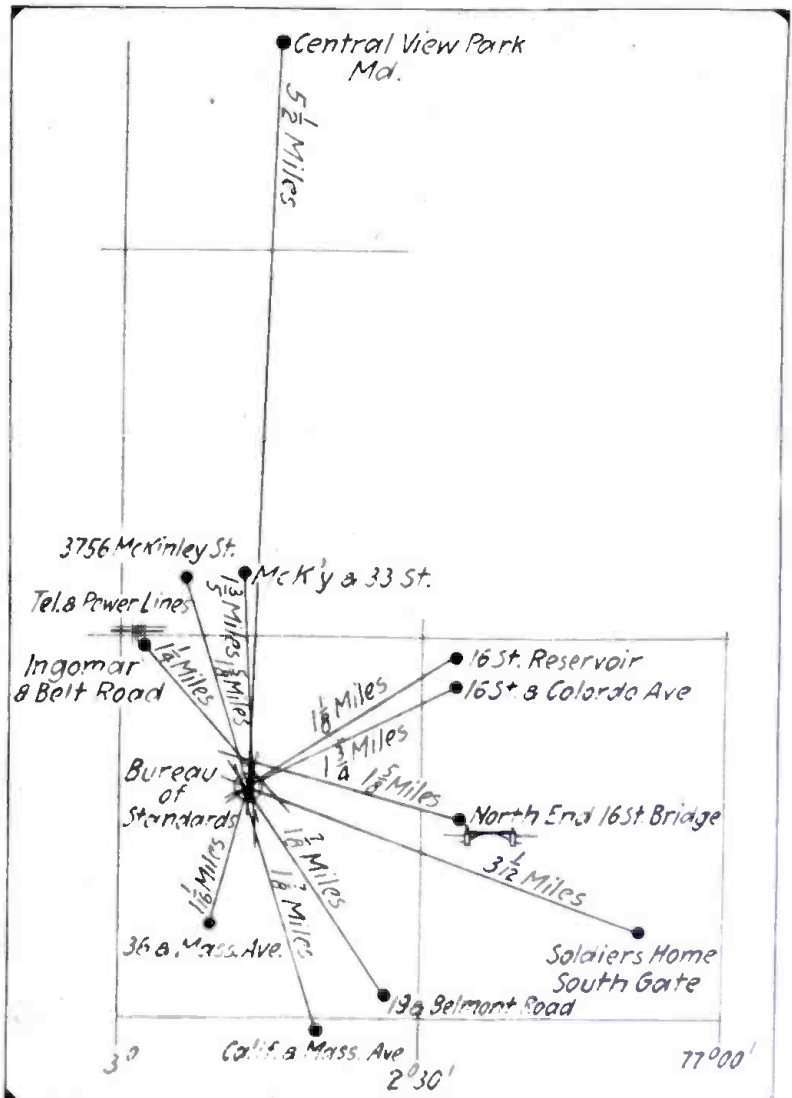

Showing a Plot of the Directions Taken from Various Points in the Vicinity of the Bureau of Standards at Washington.

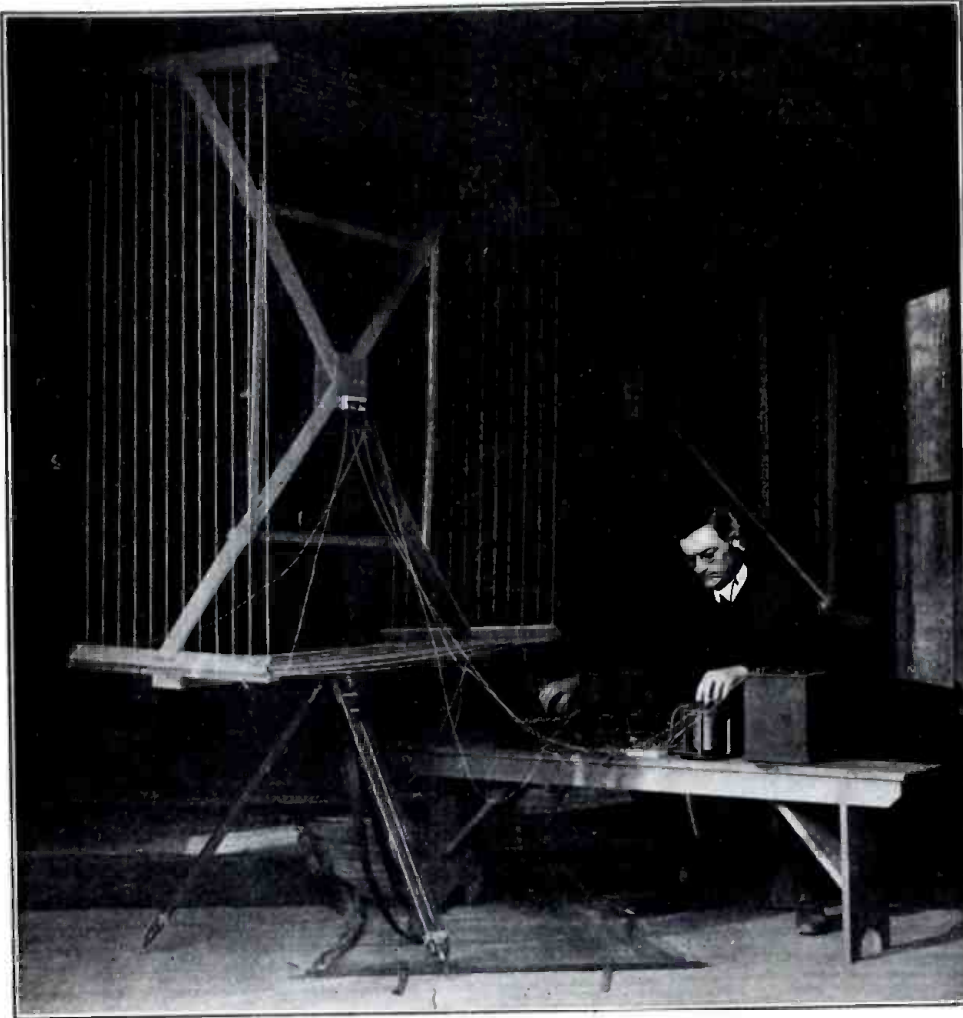

The Above Photograph Shows a Type of Loop Antenna Used in Radio Compass Experiments at the Bureau of Standards. The Engineer Is Shown Making Adjustments in Order to Locate a Distant Transmitting Station.

is the length of the waves which travel between the stations. These waves are commonly designated by the wave length. The waves ordinarily used are from a few hundred feet to a few miles in length.

One of the results of this research on the direction finder was to provide a way of selecting the particular wave which it is desired to receive and excluding others. By turning the direction finder so that its direction is such as not to be affected by a particular wave, that wave is thereby excluded, and a wave may then be received from any other station even tho farther away.

The results of experiments made with the portable direction finder illustrated here are shown in the diagram. A transmitting set was operated at the Bureau of Standards, and the direction finder was taken to points a few miles in various directions from the transmitter. The direction was determined accurately to about one degree, as shown by the lines intersecting at the building where the transmitting station was located. Two of these lines do not strike the correct point. This deviation was caused by the presence of considerable masses of iron where the direction finder was used.

Thus an interesting problem was presented by local distortions and means of overcoming these had to be devised. It is not difficult to see that such apparatus can be used to locate not only the direction but also the actual position of a transmitting station. The direction is observed, and the direction finder is moved to another point a known distance away and the direction observed again. From the data thus obtained the exact location of the transmitter is determined. This principle can be applied so as to locate airplanes as well as

radio stations on or under the surface of the earth or ocean.

#### USE OF THE DIRECTION FINDER IN FOG SIGNALING.

One valuable peace-time application of the direction finder is being developed by the Bureau. This is the use of the direction finder in fog signaling. The light at a lighthouse made useless during a heavy fog can be supplemented by a radio system. Thus at dangerous points on the Atlantic coast there are to be automatic radio transmitting sets which send out regular signals at definite intervals. A ship's captain or operator listening with his simple receiving outfit hears the signal repeated at intervals when he gets within range of the lighthouse. This automatic transmission is sometimes called "canned radio." If the ship is equipt with a direction finder, which is the simplest and cheapest of receiving outfits, he determines the direction of the lighthouse by merely rotating the coil which constitutes the direction finder. By taking two or more such observations a known distance apart he can determine his exact position. The Bureau of Standards and Bureau of Lighthouses are cooperating in developing this system.

#### DIRECTION FINDERS EQUALLY EFFECTIVE IN USE UNDER WATER.

It has always been believed that the radio waves could not penetrate below the surface of the earth or the ocean. The surface materials are considered to be conductors and impenetrable by the radio waves. Two of the young experimenters at the Bureau of Standards, however, having placed a direction finder coil under water one day in November, 1917, to their surprise received signals virtually as good as were received

in the air. They immediately asked why could not signals be received if this coil were attached to a submarine. Having secured permission from the Navy Department to conduct experiments, they spent the summer of 1918 at the submarine base in developing a system of radio communication for submarines.

The apparatus is of the most remarkable simplicity, being a single turn of wire attached on the outside of the submarine. With the submarine and its receiving apparatus and all equipment entirely submerged, signals transmitted from Paris, Rome, and California were easily received. It is also possible to transmit from this simple coil aerial a distance of several miles when the submarine is entirely submerged. Furthermore, this aerial is a satisfactory direction finder just as when used in air. This is the only thoroly successful system that has been developed for communication with submerged submarines, and the Navy has equipt its largest submarines with it.

#### WHAT THE DIRECTION FINDER MEANS TO THE AVIATOR.

The direction finder, or radio compass, is most useful to the aviator. It cannot be affected by the forces produced by his rapid evolutions when in the air but gives him a reliable means of determining his location with respect to a known point on the ground. The utility of this apparatus in enabling the aviator to steer toward his landing field is now being supplemented by experiments carried on by the Bureau of Standards and the Post Office Air Mail Service with the view of giving the aviator a positive and accurate signal when he arrives exactly over his landing field. This enables him to land even in heavy fog or in utter darkness. The method, again an exceptionally simple one, is the use of induction from a large coil of wire located on the landing field, carrying an alternating current. The effect of this extends only over the landing field itself and is exerted on a coil of wire on the airplane just when the aviator is over the landing field. The advantage of this system is not alone the actual utility to the aviator but also the psychological effect in the added sense of security which it gives him.

#### BUREAU OF STANDARDS LEADS IN RADIO MEASUREMENTS.

No less interesting to the technical man have been the developments along the lines of measurement. The scientific facts, the knowledge of which has made possible the improvements which have been described, could never have been discovered without careful measurements of the phenomena which take place in connection with the use of high-frequency radio currents. The reader does not need to be told that these measurements are more complicated and specialized than measurements with a yardstick. In this matter of measurements the Bureau of Standards is the recognized

(Continued on page 432)

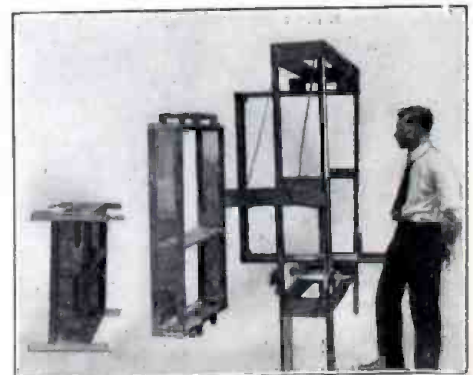

Here Is Shown Another Type of Loop Antenna in Which the Loop Coil May Be Detached from the Frame.

# The Armstrong Super-Autodyne Amplifier

## Part I

By H. W. HOUCK

THE purpose of this article is to give the experimenter sufficient data to construct and operate an Armstrong Super-Autodyne Amplifier. Radio men in general are now familiar with the more outstanding advantages of the new amplifier, such as quietness of operation, unchanged tone of spark signals and non-distortion of telephonic speech. These and other advantages will be taken up in greater detail later. Before going into constructional details and circuit constants of such an amplifier we will give a brief resumé of high frequency amplification and its advantages, difficulties encountered, and the various solutions of this problem which led up to the Armstrong Amplifier.

### RADIO OR HIGH FREQUENCY AMPLIFIER.

To the average radio experimenter the term "amplifier" means two or more vacuum tubes in cascade after the detector. With this detector arrangement the incoming signals of radio frequency are detected (or rectified) to make the signals audible in a telephone receiver, amplifier, or other audio frequency device. (By the term audio frequency we mean frequencies that are within range of the human ear.) The purpose of the audio frequency amplifier is to amplify the unidirectional impulses obtained from the detector. See Fig. 1.

The disadvantages of audio frequency amplification, however, are pronounced. If the amplifier is correctly designed and operated with the best low frequency transformers available, and the tubes are used in the most efficient circuits, more than two stages of amplification are undesirable, because an efficient amplifier of this type will make readable only signals which the most sensitive detector will rectify. Signals which are so feeble that they will not operate the detector can not be amplified by low frequency amplification, regardless of the number of tubes used. Another great disadvantage of low frequency amplification is that noises from mechanical and electrical sources are greatly amplified in the telephones, due to the audible period of the circuits, thereby giving much interference with otherwise readable signals. The more common sources of noise due to mechanical causes are mechanical vibration of the tube elements caused by vibration of the table, noises about the operating room, etc. This may be shown by gently tapping the first tube of an amplifier with the finger. Electrical noises are the most numerous and include erratic electron emission from the filament, due to unhomogeneity of the filament, filament and plate battery noises, poor grid leaks, etc. Low frequency regenerative action producing what is commonly known as "howling" or "singing", is one of

the greatest drawbacks to low frequency amplification of two or more stages.

Having briefly outlined the limitations of low frequency amplification, we are now able to appreciate the effectiveness of radio or high frequency amplification. As we are

rectified impulses readable, the obvious thing to do is to apply the incoming signals to an amplifier *before* detecting them, in order that extremely weak currents may be strengthened sufficiently to operate the detector. In other words, we are amplifying incoming or radio frequencies.

### ADVANTAGES OF HIGH FREQUENCY AMPLIFICATION.

The effectiveness of high frequency amplification is made further apparent when vacuum tube detectors are used, as the sensitiveness of these devices is proportional to the square of the voltage applied to them. In other words, if the incoming signal is amplified to double its normal voltage, the strength of signal in the plate circuit of the detector tube will be four times as great as before.

Another advantage of high frequency amplification is that "howling" is less troublesome. As has been shown, howling in a low frequency amplifier is due to regenerative or feedback action of the audible frequency circuits. As the cir-

cuits of high frequency amplifiers are not of an audible period, it is easily seen that while regenerative action is possible, and in fact occurs quite frequently, it usually does so at frequencies above audibility and hence is not apparent. Due also to the fact that the circuits are turned to an inaudible period, ordinary mechanical and electrical noises, while present, are not amplified. The elimination of audio frequency howling and of tube noises is of the greatest importance as it makes possible the employment of more stages of amplification than would be possible otherwise. Moreover after we have used as many steps of high frequency amplification as can be advantageously employed it is always possible to connect an audio frequency amplifier after the detector thereby obtaining the advantage of low frequency amplification without detrimental results. Regenerative action between the low frequency and the high frequency amplifier circuits is impossible due to the great differences of frequency. Other advantages of radio frequency amplification are selectivity, and reduction of the static signal ratio.

### DIFFICULTIES OF HIGH FREQUENCY AMPLIFICATION.

We have seen that radio frequency amplification has escaped the main disadvantages of audio frequency amplification largely because of the higher inaudible frequencies employed. However, we have unwittingly come into other difficulties because of these extremely high frequencies, which, while not unsurmountable are in some instances very objectionable. This is especially true when signals below 500 meters (frequencies above 600,000 cycles) are used. Before

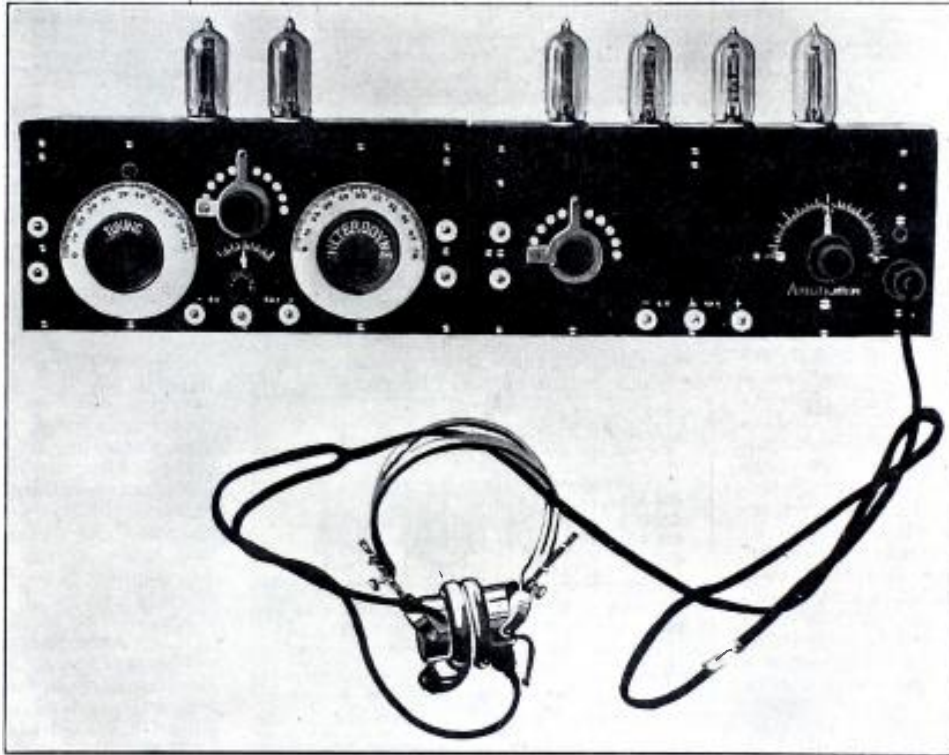

Fig. 6—One of the First Complete Armstrong Amplifiers Built in Mr. Armstrong's Paris Laboratory. The Cabinet at the Left Contains the Tuning and Heterodyne Circuit and at the Right the Amplifying Cabinet is Shown.

mainly interested in bringing in distant signals of low power, and making them

*We take great pleasure in presenting to our readers Mr. Armstrong's latest invention, the super-autodyne amplifier. As its name implies it is indeed a super-amplifier, which amplifies signals that previously could not be heard, to an astonishing volume of sound. It is doubtless the latest word in detecting and amplifying signals. American amateurs can be proud of this latest invention by an ex-amateur, now a distinguished researcher.—Editor.*

readable, and as the low frequency amplifier is useful only in that it makes weak

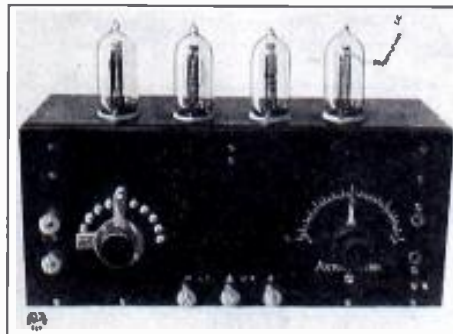
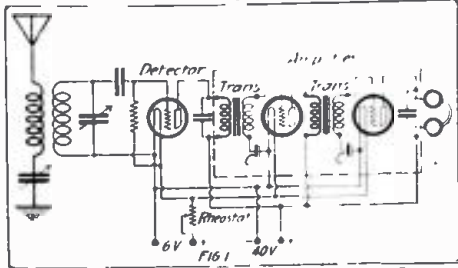

Fig. 8—The Radio Frequency Amplifier is Contained in This Cabinet; Also the Last Detector. Note the Absence of Complicated Controls.

taking up these difficulties it will be necessary to briefly consider the circuit of a simple radio frequency amplifier, Fig. 2. If we connect the "input" terminals of the



The Ordinary Audio Frequency Circuit Using Iron Core Transformers Between Stages.

amplifier directly to the tuning system and substitute a receiving transformer or loose coupler shunted by variable condensers in place of each audio frequency iron core transformer, we have a radio frequency amplifier capable of amplifying incoming signals. It is then only necessary to connect its "output" terminals to a crystal or vacuum tube rectifier and telephones in order to make the receiving system complete. To adjust such a receiver to 600 meters, for example, it is necessary to tune the antenna and secondary circuits of each of the two amplifying transformers to 600 meters, six circuits in all, and to adjust the coupling of all three transformers. While such an amplifier gives high amplification for the number of tubes employed there are several disadvantages inherent in such a system which renders its use impractical for ordinary purposes. Tuning each transformer separately to a given signal takes so much time that a signal could easily be lost. In fact the system is so highly selective that it is inadvisable to use it at all, except for reception at a fixed wavelength from some given station. Amplifiers have been built with the tuning somewhat simplified by using fixed coupling, making the primaries aperiodic, and controlling the secondaries by means of one knob, but due to the fact that fine tuning was impossible and because of mechanical difficulties these sets are not in wide use.

The tuned circuit amplifying transformer system may be made slightly broader in tuning by making the windings of resistance wire thus making the amplifier circuits slightly aperiodic, with the advantage of decreased selectivity as a result. The natural result of such an amplifying transformer is a decrease of signal strength over that obtained with a tuned circuit transformer system, but in most cases, the advantages of broader tuning more than compensates for the decreased telephone current. Both of the above types of transformer coupling between successive stages of amplification are subject to the disadvantage which has not been mentioned up to this point, that is, high frequency regenerative action. While such action does

occur quite frequently, in fact more so than is ordinarily supposed, regenerative or coupling back between tubes is of no great disadvantage unless beats of an audible frequency occur. If such beats do result, we have howling or singing. There are various ways to partially prevent regenerative action.

One very common method consists in the employment of iron cores in the transformers. To reduce the losses

due to eddy currents and hysteresis, special transformer iron of about one thousandth of an inch in thickness is used. A closed core or shell type core prevents much leakage of lines of force, resulting in less liability of regeneration occurring. Besides being very compact as compared to air core transformers, it is possible to obtain step-up ratios of voltage transformation between successive tubes, which greatly increases the amplifying power of the complete amplifier. The iron core is usually wound with comparatively few turns of very fine copper wire, and a small air space left between the core and the winding. With this arrangement it is possible to cover a limited range of wavelengths. The transformer is practically non-adjustable in wavelength range, and is slightly more efficient than the air core resistance wound transformer.

Another type of radio frequency amplifier coupling in wide use is the resistance coupled amplifier. This consists of a high resistance (non-inductive) on the order of the output impedance of the preceding tube, and is substituted in the circuit in much the same manner as a one to one single winding or auto transformer (See Fig. 3). This method is compact, has no stray field, and is aperiodic, thereby allowing a very wide range of tuning, the resonance curve of which is almost flat. Its disadvantages

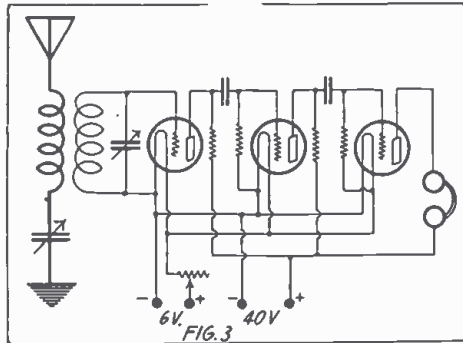

Here is Another Type of Radio Frequency Amplifying Circuit in Which the Resistance Coupling is Used.

are,—that it is not as efficient as the types previously described, requires high values of plate battery voltages, and is more inefficient at lower wavelengths than other types.

Unfortunately for the radio experimenter, none of the above methods of radio frequency amplification are practical or efficient at the short wavelengths which are available for amateur use. In fact a resistance coupled amplifier when used at two hundred meters with the ordinary vacuum tube will give less energy amplification than one would ordinarily expect for any given number of tubes, and if the wavelength is short enough, the effective telephone current fluctuation will be less than that obtained were the amplifier discarded and a detector alone used.

None of the amplifiers mentioned above

will give satisfactory results at two hundred meters or less. The reason for this low efficiency is obvious. In the resistance coupled amplifier, for example (See Fig. 3)

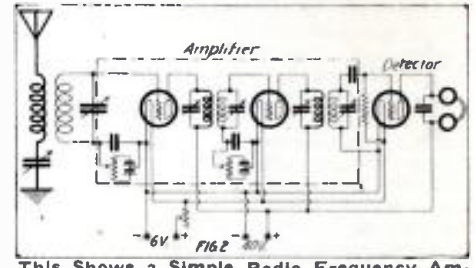

This Shows a Simple Radio Frequency Amplifier Using Magnetic Coupling Between Stages.

it is seen that each tube is connected across the resistance coupling between it and the preceding tube. Now the capacity of the vacuum tube is of such value that its reactance at two hundred meters (1,500,000 cycles) is very low compared to the resistance of the coupling. For example, if the resistance coupling has a value of 50,000 ohms and the tube a capacity of possibly fifteen micro-micro-farads, the reactance of the condenser would be about 7000 ohms, which together with the additional tube capacity of the remaining stages would have the effect of short-circuiting the resistances. Some receiving vacuum tubes have capacities of 25 to 30 micro-micro-farads. One method of obtaining a radio frequency amplifier for short wavelengths consists of utilizing tubes with very small elements and separating the terminals so that tubes of very small capacity result. An amplifier using these tubes gave fairly efficient results at wavelengths slightly in excess of two hundred meters.

ARMSTRONG'S SOLUTION.

The problem of efficient radio frequency amplification at short wavelengths remained unsolved until E. H. Armstrong solved it for all practical purposes.

Briefly, this method consists in lowering the frequency to some constant predetermined value before applying to the fixed radio frequency amplifier, which will of course, amplify the signals without difficulty. The amplified signal is then fed into a detector in the usual manner.

A schematic circuit diagram of this simple but ingenious receiver is shown in Fig. 4. Here the signal energy is transferred to the secondary circuit LC, which in turn is coupled to the local source of oscillations H, which is adjusted to such a frequency that the resulting beat frequency is equal to that of the fixed radio frequency amplifier. The beat oscillations present in circuit LC are rectified at D, and the resulting reduced radio frequency oscillations coupled to the fixed frequency amplifier thru a non-adjustable tuned transformer L<sub>1</sub> L<sub>2</sub>. If, for example, the fixed frequency amplifier is adjusted for 50,000 cycles, and we wish to tune to a signal of 200 meters

(1,500,000 cycles) we adjust the local oscillation generator, the antenna and secondary circuit CL for loudest response in the telephones. When this condition is obtained, CL will be adjusted to 1,500,000 cycles, the local oscillation source H to either 1,550,000 or to 1,450,000 cycles, and the resulting beat frequency rectified and applied to the tuned circuit C<sub>1</sub> L<sub>1</sub> and then to L<sub>2</sub> C<sub>2</sub> from whence it is amplified and detected in the usual

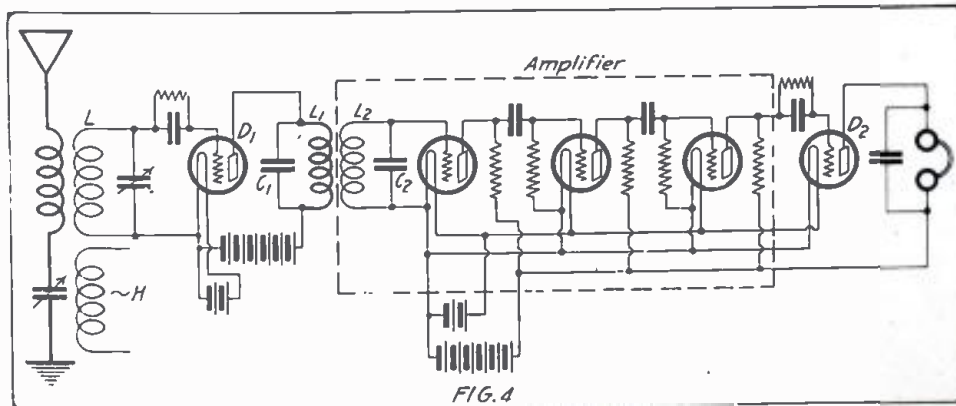

The Schematic Circuit Diagram of the Armstrong Receiver. The Vacuum Tubes D<sub>1</sub> and D<sub>2</sub> Are Used as Detectors While the Remaining Tubes Are Used as Radio Frequency Amplifiers.

manner with a tube.

The theory of this type of amplifier is quite simple, and its advantages are numerous. Of course the main drawback to high frequency amplification at short wavelengths, that is,—tube capacity, has been overcome by reducing the frequency. The method used in reducing the frequency has given increased amplification due to the heterodyne effect. The Armstrong system has all the advantages of high frequency amplification at low frequencies. What at first thought seems very strange, but is nevertheless true, is that spark signals are not "mushy" but retain their original characteristic tone. Moreover, telephonic speech is not distorted due to the frequency changer system, and if the amplifying system is correctly designed, will give amplified voice reproduction exactly following that of the incoming voice currents.

**CONSTRUCTION OF AN EXPERIMENTAL ARMSTRONG AMPLIFIER.**

The following details of an experimental Armstrong Super-Autodyne Amplifying Receiver, utilizing resistance coupling in the amplifier and a vacuum tube oscillation

generator will be of interest to experimenters desiring to build this apparatus.

An amplifier with these circuit constants has been used successfully at wavelengths of 150 to 200 meters. Various changes may be put in at the experimenter's discretion, but in general the constants given should be adhered to. The antenna or loop circuit must, of course, have a wavelength range covering the ranges desired to receive. If

difference. The transformer coupling to the first frequency amplifier may best be made by clamping together two similar honeycomb or other coils of the correct inductance. Inductance should predominate in the secondary of this transformer. In some instances it may be convenient to make one of the shunt condensers of fixed value, and the other a variable condenser,

(Continued on page 439)

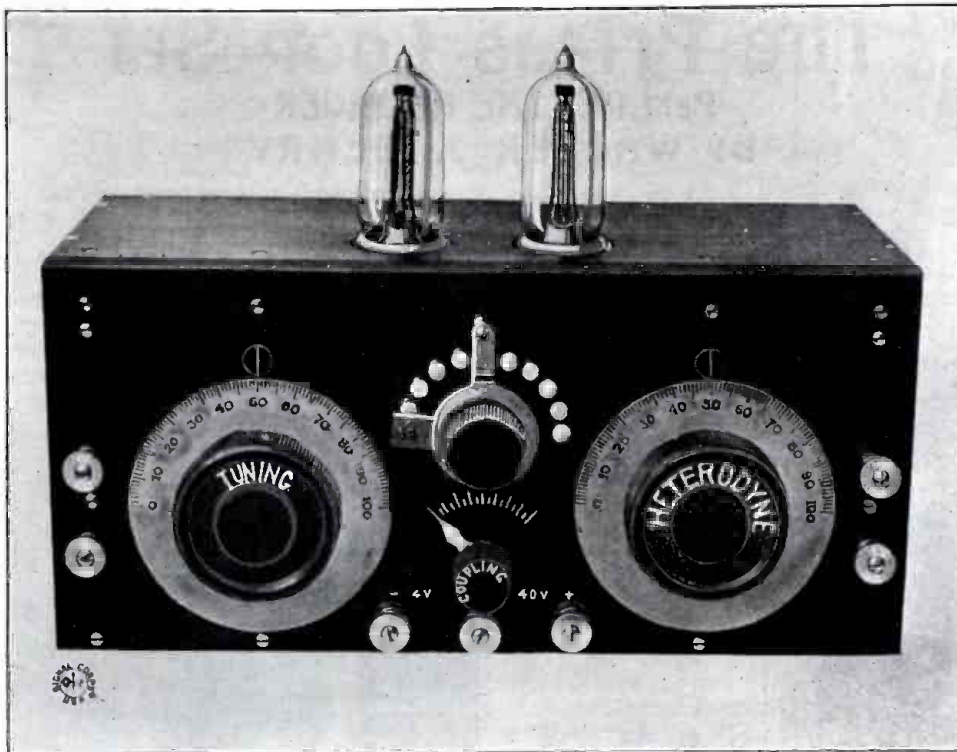
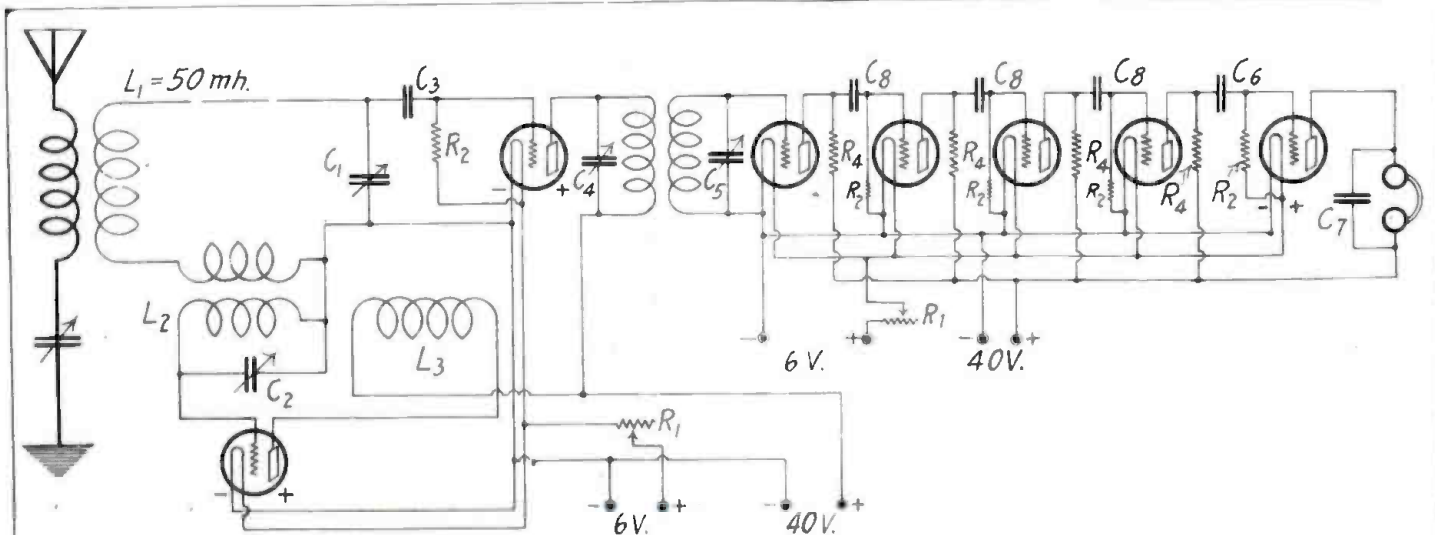

Fig. 7—Practically All Adjustments Are Made In This Part of the Apparatus. The Knob at the Left Controls the Tuning Arrangement, While the Oscillation Generator is Adjusted by the Knob at the Right. The Filament Current Is Varied in Steps by the Upper Control in the Center; the Lower Control Varies the Coupling of the Oscillator.



$R_1 = 10 \text{ Ohms}$

$R_2 = 1 \text{ Megohm}$

$C_1 = .0005 \text{ mfd. Variable}$

$L_2 = 18 \text{ Turns of } \#30 \text{ D.C.C. Wire Wound on a Tube } 2\frac{1}{4} \text{ In. Diameter}$

$L_3 = 18 \text{ Turns of } \#30 \text{ D.C.C. Wire Wound on the Same Tube}$

Close to  $L_2$  and in the Same Direction.

$C_2 = .001 \text{ mfd. Variable}$

$C_3 = .0001 \text{ mfd. Fixed.}$

$C_4 = .0005 \text{ mfd. Max. Variable}$

$C_5 = .0005 \text{ mfd. Max. Variable}$

$C_6 = .0001 \text{ mfd. Fixed.}$

$C_7 = .001 \text{ mfd. Fixed}$

$C_8 = .0005 \text{ mfd. Fixed.}$

$R_4 = 50,000 \text{ Ohms.}$

FIG. 5

A Complete Circuit of the Armstrong Super Auto-Dyne Amplifier is Shown Here. The Vacuum Tube at the Lower Left is the Oscillation Generator Which in Combination with the Next Rectifying Tube Serves to Lower the Frequency to the Amplifier. The Amplifier Includes the Next Four Tubes. The Remaining Tube is the Rectifying or Detector Tube. The Various Circuit Constants Are Also Shown.

# The Priess Loop Set

## Part III. THE RECEIVER

By WALTER J. HENRY\*

**T**HE receiver section of the Priess Loop Set consists of two turns in the loop, series connected, and placed across the vernier oil condenser described in article No. 2. It is interesting to note here that this same oil

and the loop turns in proper connection with the vacuum tube. It also connects the storage battery in series with the filament of the tube.

On the right hand side of the set is a filament switch directly over the jacks for

operating in the "receive" position, 100 hours life will be obtained using a four-volt, 100-ampere hour, lead battery.

The rotary switch at the lower left of the panel marked "Signal Intensifier" controls the adjustment of a variable air con-

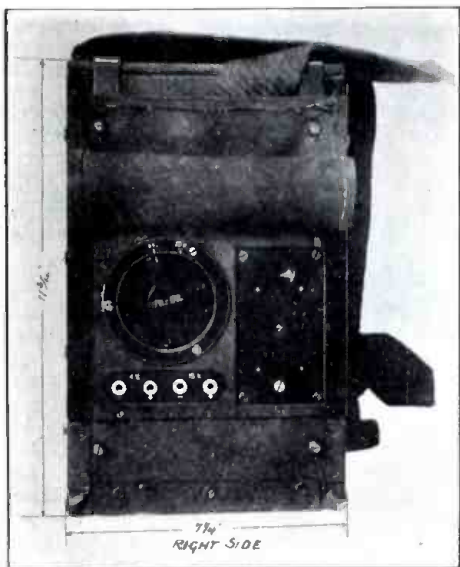

The Upper View Shows the End Construction of the Priess Loop Set. Note the Filament Switch, Also the Jacks for the Battery Connection. At the Right is Shown the Complete Set. On the Open Panel is Mounted a Voltmeter for Testing the Plate Battery.

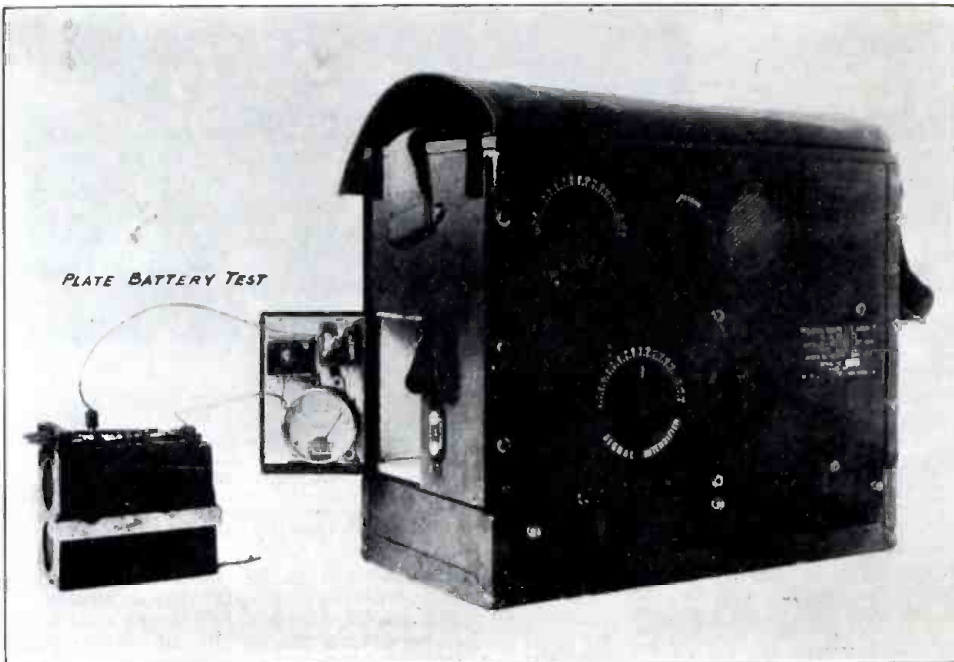

condenser is used in both the transmitting and receiving circuits. A vacuum tube is used as a detector, and the circuits are so arranged that this tube may pass from the detecting to the oscillating stage and operate at the extremely sensitive intermediate or regenerative point. This is accomplished by connecting one side of the third turn of the loop with the plate of the vacuum tube, and the other side to the filament of the tube thru a forty-volt dry battery and the telephones. Around the telephones and plate battery is placed a variable air condenser for adjusting the coupling between the plate and antenna circuits. For very small values of capacity the tube acts as a detector and for large values as an oscillator. Intermediate valves are used in normal receiving.

The transmit-receive switch used in this set is worthy of note. While it is similar to the usual multipole double throw switch in that it has a low resistance and is positive in its operation, it differs in the mechanical method used for its operation and is also contained dustproof. On receiving it connects the two rear turns of the loop in series across the oil condenser,

connecting four-volt and ten-volt batteries. The idea here is to conserve the power of the ten-volt battery by using a four-volt battery for the tube on operation. Under normal operation the set is on the receiving setting so that it is only necessary to have four volts for lighting the tube fila-

denser with plates cut the same as those used in the oil condenser. This condenser is contained in an aluminum dust-proof case with a maximum capacity of .0006 mfd. The function of this condenser is to control the regenerative action of the receiver for obtaining maximum regenerative amplification on reception.

The grid condenser is the small unit mounted in front of the oil condenser, and having a capacity of .004 mfd. The grid leak has a resistance of 500,000 ohms, and consists of a strip of fibrous material coated with a carbon ink. The vacuum tube employed was a Western Electric V.T. 1 tube with an oxide coated filament.

The plate battery consisted of two standard Signal Corps 20-volt batteries, connected in series and mounted in a special aluminum container designed to combine maximum strength with maximum weight. In case of emergency an external 20-volt battery may be plugged into the set. Inasmuch as the standard Signal Corps 20-volt battery was somewhat unreliable it was necessary to provide a voltmeter for checking up this battery from time to time. A voltmeter was therefore mounted on the battery compartment door  
(Continued on page 436)

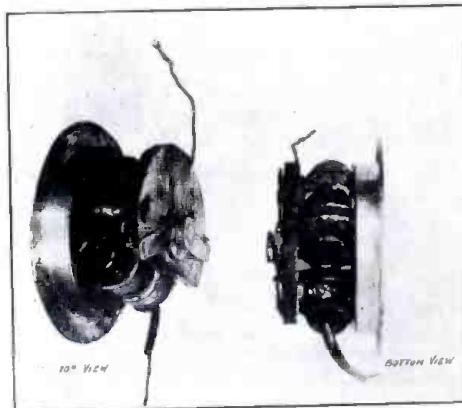

Here is Shown the Type of Rheostat Used for Controlling the Filament Current.

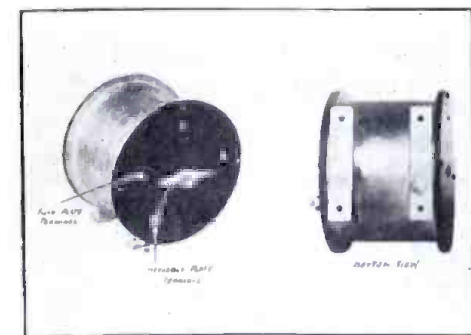

The Variable Enclosed Type Oil Condenser is Used in Both the Transmitting and Receiving Circuit.

\*Sales Manager, Wireless Specialty Apparatus Co.

ment. During an advance when the set is being carried forward the four-volt battery is left behind and the ten-volt battery then serves as a source of current for both transmitting and receiving. The switch is mounted on an asbestos board and cuts in a 6.2 ohm resistance when using the 10-volt source and a 1.15 ohm resistance when using four volts. The switch is designed so that the heat produced in the resistance is transmitted directly to the front plate and may be made to serve as warmer for an operator's fingers in the winter time by closing down the flap which covers the right hand side of the box. Heat is not transmitted into the box, to any great extent because of the heating insulation provided by the asbestos board. The set is so designed that in normal operation, that is when it is

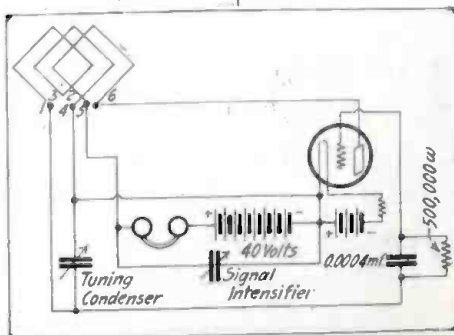

This is the Circuit Used in the Receiver. Note That the Tuning is Accomplished by the Variable Tuning Condenser.

# A Logical Way of Making Wireless Diagrams

By HERBERT WEBB

I have noticed that one of the greatest troubles an amateur has is the making of diagrams. By this I mean not the advanced fellow, who has already learned from experience, but the man who is just fairly started in radio, probably at the stage of just getting an audion.

For instance, you have a motor that you want to reverse, which is a very simple matter, and is just taken to illustrate the method. You know, to start, that the two field leads are always going to be connected to the source of power, and the armature connections or brushes are the ones that have to be changed. Draw a little diagram of the field, armature, and source of power. Then draw the connections of the power source to the field. Then number the armature leads 1 and 2. Draw a couple of wires from each of the power wires and call them 3 and 4. Then you know that for the motor to go one way, 1 must be connected to 3 and 2 to 4. For the other direction, 2 to 3 and 1 to 4. Thus you make 3 and 4 the center connections of a DPDT switch, making 1 and 2 at one end and 2 and 1 at the other, as shown in the figure.

Then supposing that you have made up

your mind to have a panel receiving set, with a long wave receiver at one end and a short wave at the other, and you are going to use only one audion for both of them. It is therefore necessary to have a system of switches to change the connections.

You again put down all of the instruments, it being unnecessary to number them. Then think a minute. Make a list of all the instruments that are to be used in both sets, such as grid condenser, audion bulb, B battery, potentiometer, rheostat, A battery, variable condensers, phones, aerial and ground.

You of course have separate diagrams of each set, namely, long and short wave receivers. Compare the two and see which parts of the two are identical. That is, how the phones, B battery, potentiometer, and grid condenser are connected, and see whether in each diagram a variable condenser is connected across the B battery and phones, or whether it is across the secondary in both cases.

Then, after all this is done, make a list of all the parts that are not common to both sets, and run the wires that are connected to them to the middle connection, or arm,

of a SPDT switch. Then there will probably be from four to seven switches, depending on how different the two connections were to start with.

Then when all of the switches are thrown upward, say, that would be the long wave connection, and when they are thrown downward that would be the short wave. Then wires are drawn connecting the short wave set to the bottom set of switch points, and also drawn from the top group of switch points to the long wave set. Then all of the desired connections will be made.

To be absolutely sure that you have the right dope on it, trace out the wires starting from any point you choose, and if this is done you may be sure that you are all to the good. Sometimes, after the connections of all of the apparatus is made in this way, some connection may be simplified. Just go ahead and do it after you are sure that it will not interfere with anything.

After you have made a few diagrams in this way, you will notice that you can do more and more work in your head, and the final result can be attained only by continued practice.

## Use of the Vacuum Tube for Sustaining Mechanical Oscillations

The three-electrode vacuum tube may be used to sustain mechanical oscillations in any system possessing inertia and elasticity, in a manner similar to that of sustaining electrical oscillations. It is simply necessary that the mechanical system be started oscillating and made to vary the grid potential of the tube in such a way that the resulting plate current variations will be of suitable magnitude and phase to sustain the mechanical oscillations. This subject has been given a great deal of space in the technical press of Europe recently, but seems to have little practical value in its present status.

As an illustration consider the system of Fig. 1, which shows how a three-electrode tube may be used to maintain undamped oscillations of a pendulum P. Two coils, Lg and Lp, are respectively inserted in the grid and plate circuits of the tube and placed in front of a small iron armature HK which is integral with the pendulum. As the pendulum is swung out of position, it oscillates back and forth, moving the end H of the armature alternately to-

ward and away from the grid coil Lg. This induces an alternating potential between the grid and filament of the tube, which in turn varies the current in the plate circuit and plate coil Lp. There results a correspondingly varying attraction of the coil Lp on the end K of the armature which, for suitable magnitude of the currents and proper polarity of the con-

nections, has such a phase relation with respect to the oscillation cycle of the pendulum as to sustain its motion continuously. The energy expenditure from the plate battery is thus seen to compensate for the friction losses which in the absence of the vacuum tube device would damp out the oscillations of the pendulum or bring it to rest.

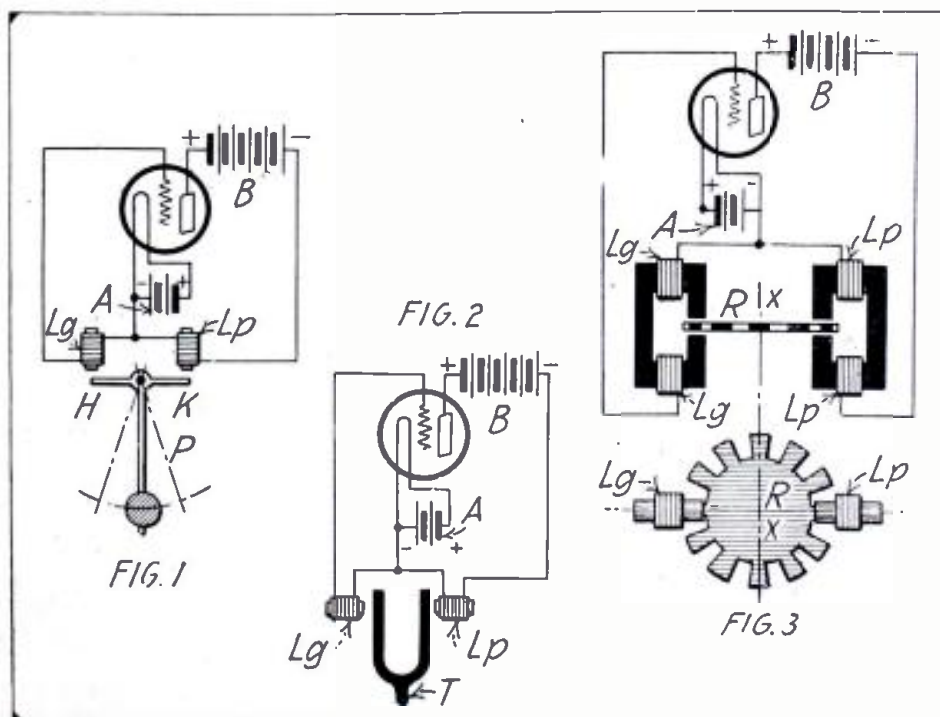

Another example is given in Fig. 2, where undamped vibrations of tuning fork T are obtained by means of grid and plate coils Lg and Lp, disposed on either side of the tuning fork. The explanation is quite similar to that just given for the pendulum. It will be noted that in both cases the plate and grid circuits are coupled magnetically to a common mechanical system possessed of a natural period of vibration or oscillation of its own. This is identical with the case of electrical oscillations where the tube circuits were inductively coupled to a common oscillatory circuit having a natural period of electrical oscillation.

(Continued on page 452)

# New System for the Reception of Undampd Waves

By LIEUT. JOHN SCOTT-TAGGART, M.C.

THE arrangement to be described is of interest largely because it solves in one way the problem of producing an undampd wave wireless receiving circuit capable of "stand-by" and "tuned" adjustment combining ease of manipulation and high selectivity. In addition, the circuits may be adjusted so as to reduce radiation to a negligible value. The complete arrangement was designed by the author and used for certain special artillery communications during the fighting of 1917 and 1918. As evidenced by reports, it proved of exceptional value in battle and overcame the difficulty, previously experienced, of interference by neighboring "spark" stations. On several occasions communication was steadily maintained with a forward station 15 km. away, altho a 2 kw. spark set was operating within 300 yards of the continuous-wave receiving station and working on a wavelength only slightly different.

The arrangement may be divided into three essential circuits A, B and C. The circuit B is of the usual type. An aperiodic retroactor (tickler) coil  $L_2$  is coupled to a variable inductance  $L_1$ ; this coupling is made variable, and if sufficiently tight will cause the circuit B to oscillate of its own accord at a frequency determined chiefly by the value of the condenser  $C_1$ . The filament of the vacuum tube  $V_1$  is heated by a six-volt accumulator B, thru a rheostat  $R_2$  of about five ohms resistance. A plate battery  $H_1$  of about 60 volts and the primary  $T_1$  of a step-up transformer  $T_1$ ,  $T_2$  are connected as shown, a fixt condenser  $C_2$  of about 0.008 mfd. being connected across  $H_1$ , and  $T_1$ , in order to bypass the high frequency component of the plate current of  $V_1$ .

The portion A is exactly the same as B except that no aerial or earth connection is made. The filament of  $V_2$  is heated by current from the common accumulator B. A double change-over switch S enables any low-frequency current supplied by  $T_4$  or  $T_2$  to be applied to an audio-frequency or note amplifier C. This circuit C possesses an inter-valve step-up transformer  $T_5$ ,  $T_6$ , a telephone step-down transformer TS TS, a pair of low-resistance telephones T, a plate battery  $H_3$  of 60 volts, a filament-heating accumulator B, and other features which will be understood by reference to the illustration.

The circuit A is placed near the circuit B so that an inductive effect is obtained. The distance between A and B should preferably be variable, and for eliminating interference the author has placed A as much as six feet away from B, altho one to two feet is more usual.

While "listening-in," the switch S is placed over to the right, and all reception is accomplished by means of the B circuit. The coupling between  $L_2$  and  $L_1$  is adjusted until the circuits commence to oscillate of their own accord. By adjusting  $C_1$ , the tuning of the aerial circuit and the adjustment of the local frequency are accomplished simultaneously, and signals from an external undampd wave transmitting station are easily picked up. It is to be noted that signals will only be heard if the local frequency is either greater or

less than the incoming frequency by between 100 and 4,000. Beyond these limits the beats produced will, for all practical purposes, be inaudible. By gradually increasing the capacity of  $C_1$  continuous-wave signals are first heard in T as a high note, which will gradually decrease as the capacity of  $C_1$  is increased. A silent point will ultimately be reached, and under these conditions the local frequency will equal the incoming frequency. The aerial circuit will now be exactly tuned to the incoming frequency. As the value of  $C_1$  is increased still further, beats will once more be formed, and a note will be heard which will gradually increase in pitch as the

of efficiency due to mistuning is at a minimum. If this secondary effect were absent, the loudest beat notes would, in the case of an average pair of telephones, have a frequency in the neighborhood of 1,000.

The advantage of rapid adjustment while making the arrangement suitable for "picking-up" signals renders it open to serious interference from spark stations. Another very important disadvantage is that the circuit radiates while receiving. The B circuit acts, in effect, as a small power transmitter which will cause incalculable interference with other continuous-wave receiving stations within a few miles radius. It is safe to say that in nine cases out of ten the local oscillations are far stronger than necessary. Unfortunately attempts to decrease the oscillating energy usually result in stopping the circuits oscillating or impairing the detector efficiency of the circuit.

The disadvantage of excessive jamming may very largely be overcome by tuning the oscillating B circuit to the silent point of signals, decreasing the coupling between  $L_2$  and  $L_1$ , or decreasing the filament current of  $V_1$ , so as to prevent  $V_1$  from oscillating, and then switching S over to the left and retuning on the circuit A, which is made to oscillate. The complete arrangement now acts as if an aerial circuit were very loosely coupled to the oscillatory circuit  $L_2$   $C_1$ . The filament or plate voltage of  $V_1$  may be dispensed with, and signals will still be heard if the circuit A is tuned to oscillate at a frequency slightly different to the incoming frequency. Owing to the very loose coupling between  $L_1$  and  $L_2$  spark signals suffer in amplitude to a

much greater extent than continuous-wave signals which persist. Another advantage of the arrangement is that the energy radiated from the aerial is merely that induced by the circuit A, which is a negligible amount if the distance between A and B is considerable. The chief disadvantage of the arrangement lies in the fact that considerable inefficiency is caused by the impedance of the mistuned circuit  $L_2$   $C_1$ .

A further development which leads to much louder signals is to adjust the B circuit to the pre-oscillatory or subgenerative condition immediately preceding self-oscillation, by increasing the coupling of the retroactor coil  $L_2$  or the magnitude of the filament current, of which the latter adjustment is preferable. The incoming continuous waves are now retroactively amplified, a phenomenon which has received scant attention as applied to continuous waves. Thru the retroactive effect, which partakes of the nature of a negative resistance, the energy losses are decreased, and the amplitude of incoming signals increases, much louder results being obtained in the telephones T.

The ratio between the amplitudes of local and incoming oscillations is of great importance, and its effect will be very noticeable on the circuit under discussion, which allows for considerable variations of the ratio.

Let us suppose that the amplitude of the local oscillations is L and that of the incoming signals is I. We will readily see  
(Continued on page 438)

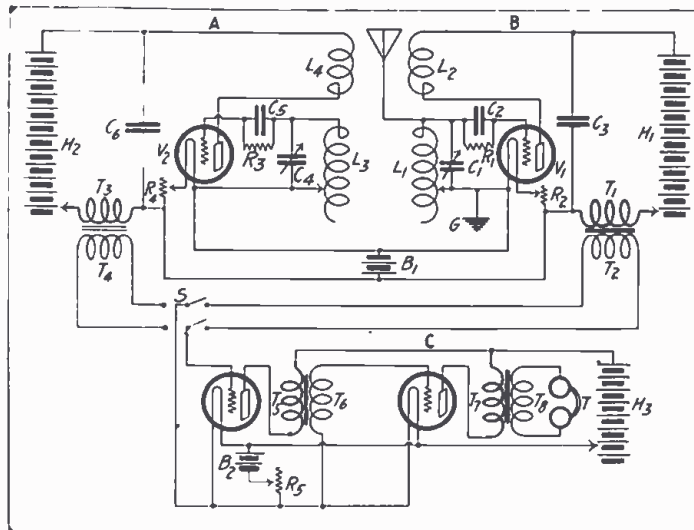

The Circuits Shown Here Possess the Advantages of "Stand-By" and "Tuning" Adjustment with the Combination of Ease of Manipulation and High Selectivity; Also the Circuits May Be Adjusted so as to Reduce Radiation to the Negligible Value.

capacity of  $C_1$  is increased, until it passes the audible-limit.

The signal strength obtained on this circuit B will depend to a certain extent on the value of the coupling between  $L_2$  and  $L_1$ , the plate voltage, and the filament current. The cumulative method of grid rectification is employed, a grid condenser  $C_2$  of about 0.0003 mfd. being shunted by a resistance  $R_1$  of about 3 megohms. Apart from the correct choice of a suitable operating point on the grid and plate current curves, we are also concerned with the correct adjustment of the amplitude of the local heterodyning oscillations. This adjustment cannot conveniently be made, a disadvantage which is keenly felt.

It will be seen that for a beat note to be produced, the aerial circuit must be slightly mistuned, in order to produce local oscillation of a frequency differing from the incoming frequency. The incoming waves force themselves into the aerial circuit in spite of the fact that the latter is out of resonance. While preserving their original frequency the oscillations have their amplitude decreased, and cause a loss in signal strength which is very noticeable in the case of weak signals. The higher beat notes correspond to greater disparities between the local and incoming frequencies. Consequently, a high beat note necessitates a very considerable mistuning of the aerial circuit, especially in the case of wavelengths higher than about 500 meters. This fact explains why the loudest signals are invariably obtained on almost the lowest beat notes, since under these conditions the loss



# Modified Government Receptor

J. STANLEY BROWN\*

**T**HE types of receivers for undamp waves in use by the government during the war astounded many former radio amateurs, who enlisted in the service, by their extreme sensitivity, their stability and their ruggedness of construction. They were wonderful pieces of work, particularly those made by former gun mechanics in the Washington Navy Yard. The controls were simple yet sensitive and the wave lengths were calibrated directly on the secondary condenser dials. However, if an ordinary mortal were to try to duplicate one for his own use he would find that the internal workings were so complex that unless he had access to a completely equipt machine shop it would be impossible to produce a likeness. Now if we look at the subject in a critical manner we find that there are many parts on a Navy receptor that are not a necessity on a first class set for experimental work. In designing the set to be described in the following pages the writer has taken this fact into account and fully believes that no better receptor for experimental undamp wave reception can be made.

Simplicity of circuits and stability of operation are the first essentials of any good set to start with, although later improvements may complicate the circuits to a certain extent. The best circuit for undamp wave reception is one composed of a primary inductance tuned with a series variable condenser, a secondary tuned with a shunt variable, a vacuum tube as the source of local oscillations with a feed-back inductance in the plate circuit which must be for best results, in variable inductive relation to the secondary inductance. The Navy standard calling wave is 4,000 meters and as very little arc work is carried on below this period our set should have a range between about 3,800 and 15,500 meters. It is not advisable to use too large a secondary shunt condenser as weak signals are apt to be the result, so it is well to choose a maximum value of .001 mfd., which is an easy size to secure in the open market. After quite a bit of experimenting the best coil that was constructed gave a wave range between 6,800 and 15,500 meters. This coil was wound with 720 turns of tightly twisted litzendraht wound in two 360 turn groups

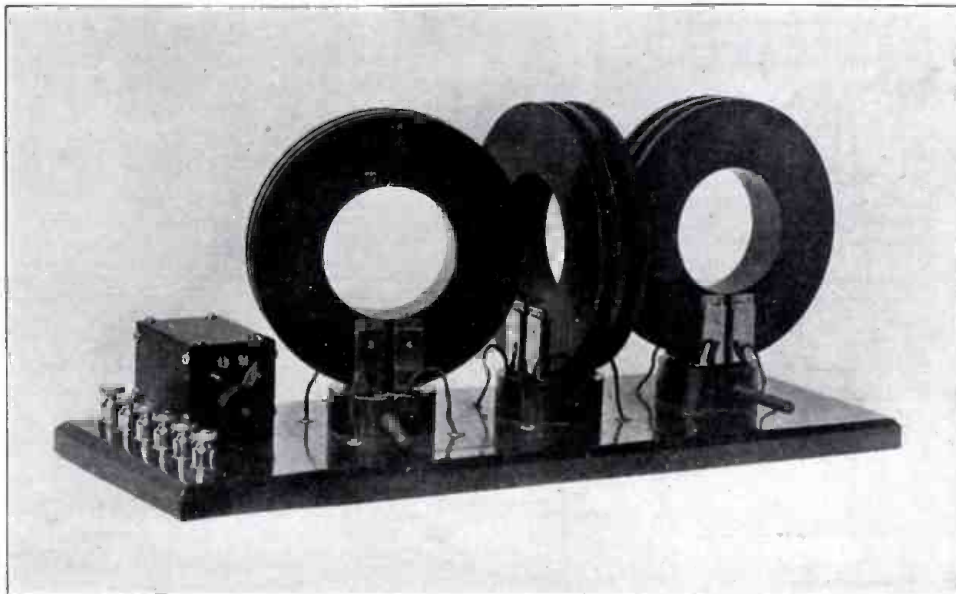

The Set of Inductances Used in the Modified Government Receptor. The Switch at the Left Is for Connecting the Coils in Series or Parallel. Note That Extremely Loose Coupling Is Employed in the Operation of This Tuner.

on the form shown in Fig. 2. This litz. was of large surface area and was made of 10 strands of No. 32 B. & S. enameled copper wire twisted tightly together with a hand drill. The primary and secondary are wound exactly alike and the leads are brought out to contacts mounted on the sides of the winding form in the manner shown in Fig. 3. In the experimental form, a photograph of which is shown, these contacts form mounting clips and the entire coil may be easily removed and replaced by another of a different inductive value if the experimenter so desires. As simplicity was to be the strong feature of our set we are adverse to the use of dead-end switches and the resulting great number of taps made necessary through their use, so a much better method was hit upon whereby there were at no time any unused sections of inductance in the field of any of the coils, while at the same time the wave-length range was from 3,800 to 15,500.

This idea was to switch both sections on each of the three winding forms in series for the longer wavelengths and to switch them in parallel on the shorter lengths. This gave two wave ranges with a .001 mfd. condenser, which were from 3810 to 7620 M. and from 6,800 to 15,500 M. respectively. An added advantage is that the higher frequency currents of the shorter wavelengths have double the conductor surface area of that present in the circuit when the longer range of waves are being received. It is well to state before going further that the plate circuit inductance or tickler coil has but 500 turns of the same wire as the primary and secondary coils.

In the original model which was constructed by one of the men at The U. S. N. Radio Laboratory at Great Lakes, the sets of coils were placed in either series or parallel by means of three telephone switches. This was inconvenient so the writer designed the switch which is shown in assembly and detail in Fig. 4. It is virtually a 6 P. D. T. switch but is in a very compact form. Fig. 5 shows the schematic hookup for the switch as well as the external circuit. It will be noticed that the coils are "Poled the same" at all times so that they will not oppose each other and thereby lower the efficiency of the inductance as a whole.

In operation the coupling is fully as loose as shown in the photograph and even the maximum coupling obtainable is comparatively loose. The mutual inductance between the primary and secondary varies so little through all the degrees of coupling that the calibration of secondary wavelengths directly on the condenser dial is entirely practical. This instrument was so selective and efficient that the operators stood watch on it in preference to the standard Navy receptor and the writer understands that after it was taken to the great Trans-Atlantic Station at Belmar, N. J., it was used for the regular watch in preference to the abundance of equipment furnished by the Navy Department.

Now that we have a thoroly efficient set that has been tried and tested under exacting conditions all that remains to be done is to so arrange it that it can be mounted in true workmanlike form in a cabinet. A

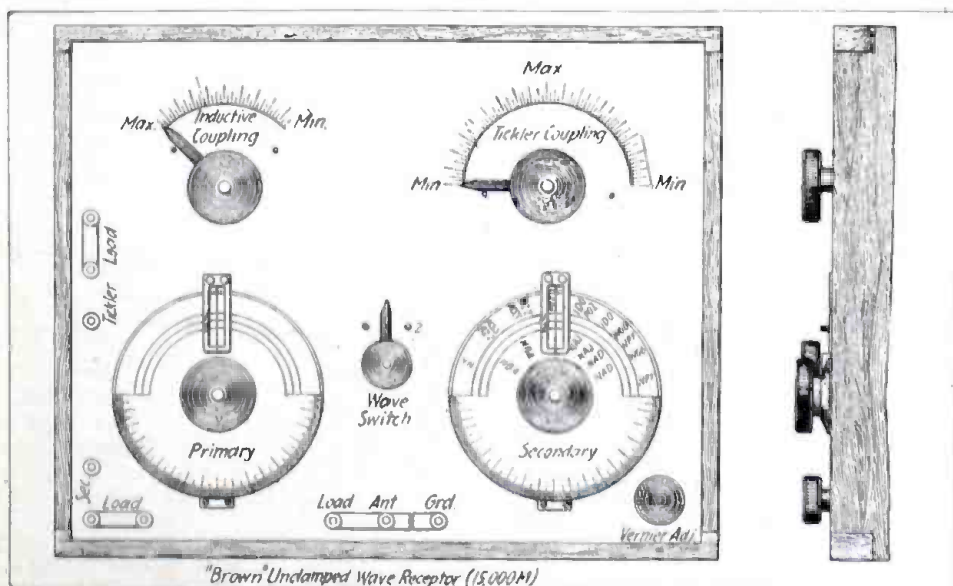

Showing the Front of the Cabinet and the Various Controls. The Dial at the Lower Right Is Calibrated So That the Tuning Is Simplified to a Great Extent.

\*Radio Engineer, Signal Electric Mfg. Co.

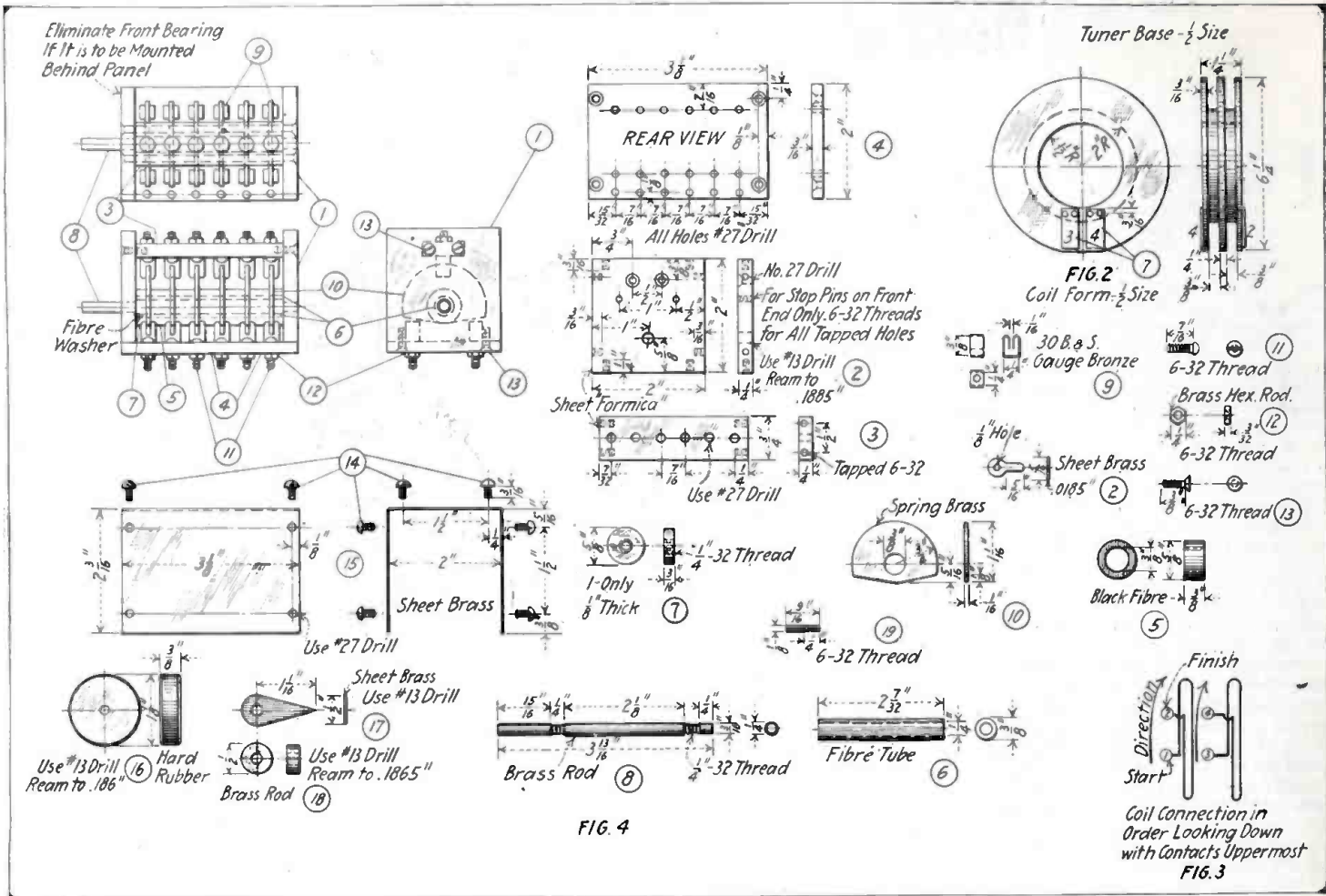

Here Are Shown the Details of the Set. Fig. 2 Gives the Dimensions of the Coil Forms. The Method of Winding the Coils Is Shown in Fig. 3. Construction of the Switch Is Shown in Fig. 4.

very compact design for such a mounting is shown in Fig. 6 and a careful study of it will prove that there is not much more to be desired by the way of additional features. It will be noticed that the coil terminals are brought directly from the wave changing switch to the front of the panel and therefore the experimenter may use any circuit he desires without altering the internal connections. Posts are provided to allow the connection of load coils and these may be shorted by the jumpers when not in use. The large dials are 5" in dia. and about 1/16" thick. They should be cut from white celluloid and the scales marked on with india ink. This will be an easy matter if the scales are first mounted on the face plate of a lathe and the glaze taken off with very fine sandpaper. The secondary scale should have the wavelengths calibrated on it by comparison with a wavemeter and it will be noticed that there is room to place the call letters of the more important stations opposite their "peaks". This is

distinctly a great method for time saving and many times it helps one to identify a station in a few seconds when it would ordinarily take several minutes. The primary scale should not be calibrated unless the experimenter is sure that he will never

change aeriols or ground wires. Resonance is easily obtained between the primary and secondary-circuits by the "click" method. It will be noticed that the secondary condenser is provided with a vernier adjustment while the primary is not. This is because the primary never tunes sharply enough to warrant such an adjustment whereas the secondary circuit tunes with extreme sharpness. The vernier knob should have a ratio of about 1 to 5 with the condenser shaft and the writer is in favor of pulleys and a crossed rubber belt in place of gears as the control will then have no "play", it will be noiseless and the dial will move in the same direction as the hand.

The recorders or indicators shown in Fig. 6 may be made of metal with a fine wire stretched across the opening or, better still, they may be made of transparent celluloid with a hair line scribed on the under side and filled with white lead. A method of scribing scales on "Formica" panels was described by (Continued on page 434)

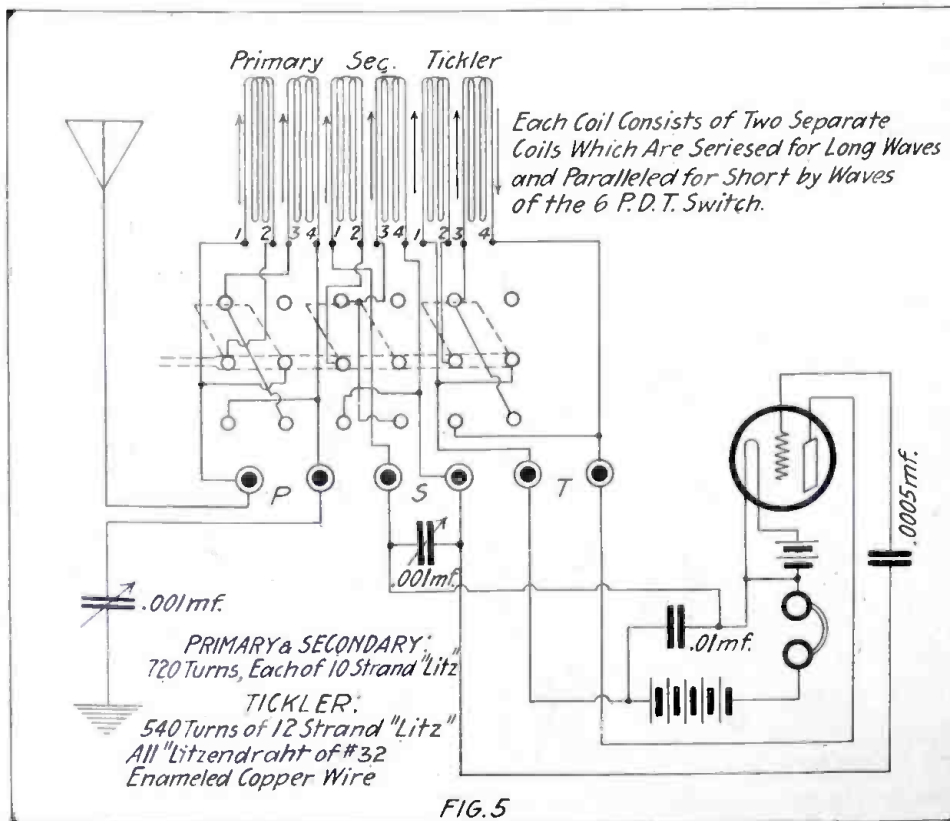

Showing the Wiring Diagram of the Government Type Receiver.

# Banked Winding and How It is Done

By H. C. SILENT

A GREAT deal has been said about the "bank winding" in the description of recent radio instruments, and many excellent designs have been printed giving full details of the construction of the apparatus up to the point where it says "Put on a two layer bank winding," and there the details stop. Inquiries regarding this particular form of coil bring forth the interesting but not at all explanatory reply that it is a form of winding in which the distributed capacity is reduced to near the minimum, and the inductance of the coil for a given amount of wire and space occupied very greatly increased over the single layer type of coil. As a particular example, the calculated inductance of a coil four inches in diameter and six inches long, wound with 216 turns (single layer) of No. 22 single silk-covered wire, would be 2,354,000 centimeters, and with a condenser of .0005 mf capacity would tune to a wave length of 2,045 meters. With a coil wound twelve inches long, four inches in diameter and 432 turns (single layer) the inductance would be increased to 5,498,000 centimeters, and with the same condenser would tune to a wave length of 3,125 meters, or about one and one-half times the wave length of the short coil. But with a coil of the same length as the first above mentioned wound with a two layer bank, having approximately the same amount of wire as the second coil, the inductance would be 9,496,000 centimeters, and with the above condenser would tune to a wave length of 4,105 meters, which is twice the possible wave length of the short single

layer coil, and one and one-third times the wave length of the long single layer coil with no increase in wire necessary and a 50% saving in space. If the above re-

little beyond the end of the preceding one before carrying it up or down, and that the bends in the wire where such turn is carried up should be made as sharp as possible in order to have a firm and neat appearing job. The winding should be kept very tight, and a slight "tackiness" to the form, obtained by having it varnished and only partially dry,—or by having grooves cut in the form, will aid materially in preventing the winding from falling. This, however, will not be necessary when one becomes more experienced in laying the winding.

Having once mastered the two layer bank winding, the three or four layer winding will be obvious. For a three layer winding put on the first five turns as for the two layers, but do not come down to the form at the fifth turn; instead, continue up until the end of the sixth, and come down on it. With a single experiment the method will be quite easily seen. Fig. 9 shows the lay of the strands in a three layer bank.

Once the art of laying a bank winding is acquired, the experimenter will use it for almost all of his coils, as of-

fering great economy in space and wire over the single layer coil, and even a coupler made for the reception of the amateurs using this form of winding will be found most satisfactory, as it may be unusually compact even tho wound with fairly heavy wire, which is quite a necessity at the short wave lengths if Litz wire is not available.

*Editor's Note.*—A coil approximating the linear dimensions of a standard honeycomb coil may be constructed along these lines by winding several one-inch layers separated by thin cardboard. A coil of this type should give excellent results.

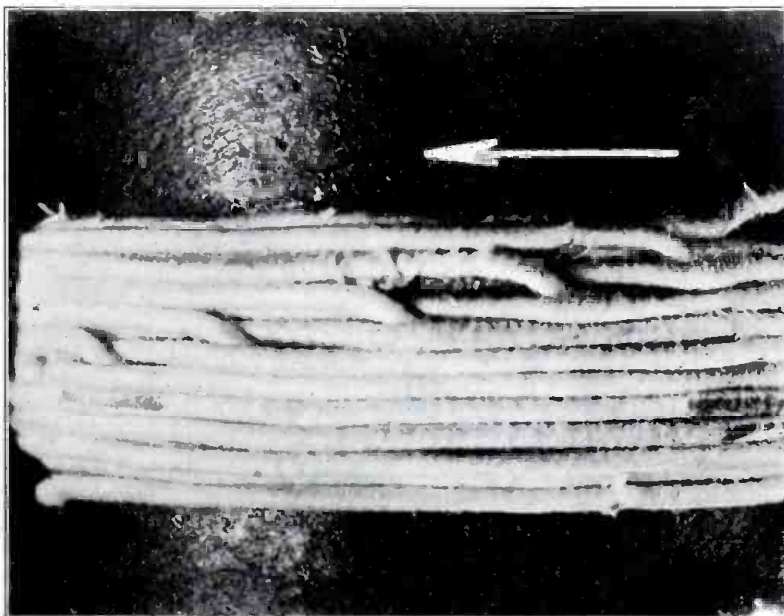

The Above Photograph Illustrates Clearly the Method for Banked Winding. By Following This the Amateur Should Be Able to Wind His Inductances Without Difficulty. The Arrow Indicates the Direction in Which the Wire is Wound on the Tube.

sults can be obtained without reducing the efficiency of the coil, the advantage is obvious, and the bank winding is nearly as efficient for radio work as the single layer type of coil. This cannot be said of the simple back and forth type of winding, as the distributed capacity of the layers so placed is very large.

The accompanying figures explain in detail the steps followed in putting on a two layer bank winding of the type devised by the Bureau of Standards and recommended by them. The wire is carried around the form for two turns as in Fig. 1. A sharp bend is then made in the strand, and it is carried to the top of these first two turns as in Fig. 2. At the completion of the third turn, the strand is carried about a sixteenth of an inch beyond this first bend, and then carried down to the tube or form again, to begin the fourth turn, as in Fig. 3. It is then carried around the form to make the fourth turn, going about a quarter of an inch beyond the place where the beginning of the turn came down onto the tube, and is carried up onto the top of the preceding two turns as before. This is the beginning of the fifth turn, Fig. 4, and after being carried around the form as for the third turn, is again brought down onto the tube as for the fourth turn, and the process repeated, Fig. 5. The completed winding will then appear as in the photograph, Fig. 8, and the strands will lie on the coil as in Fig. 7. Fig. 6 shows the side view of the winding, explaining how turn number five is carried slightly beyond turn number four before it is carried up onto the preceding turns (numbers two and four), and also shows how the beginning of turn number six is carried slightly beyond turn number five and brought down.

With these simple directions, if one will take the time to carefully try out a small winding for practice, no very great difficulty should be experienced. A couple of trials will make one expert in the laying of such a winding. The points to be noted are that each succeeding turn is carried a

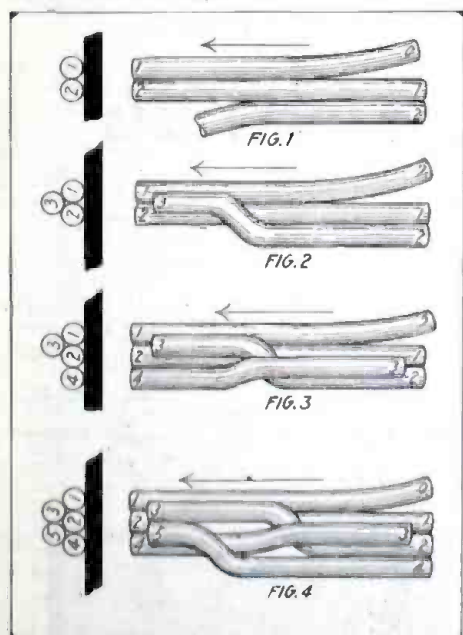

In the Drawing the Arrow Indicates the Direction of Winding. Fig. 1 Shows the Beginning of the Bend. In Fig. 2 the Bend Has Been Made and the Wire is Now Wound in the Groove, Between the First Two Turns. In Fig. 3 the Fourth Turn is Brought over the Bend, as Shown. In Fig. 4 the Fifth Turn is Bent in the Same Manner as the Third Turn.

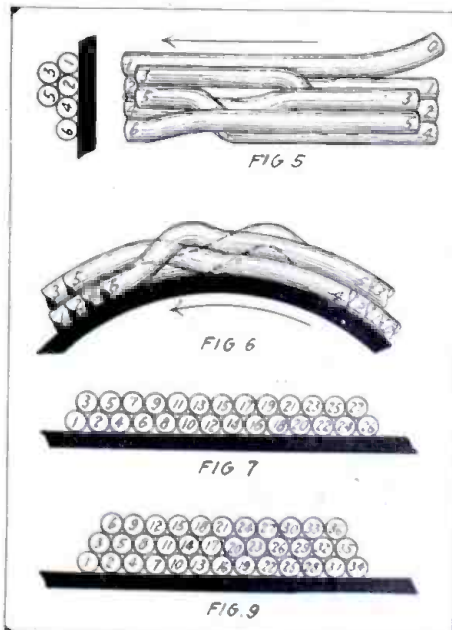

Fig. 5 Shows the Fifth Turn Brought Over the Second Bend. A Side View of the Winding is Shown in Fig. 6. Fig. 7 Shows the Cross Section and Numbers of the Wires as They Lie on the Coil for a Two-Layer Winding. Fig. 9 Shows a Cross-Section of a Three-Layer Winding.

# Improvement In Buzzer Transmitters

By EDGAR TERRAINE JOHNSTON

WE have never been able to employ buzzers as transmitters for any appreciable distance mainly because the amplitude of the current radiated was

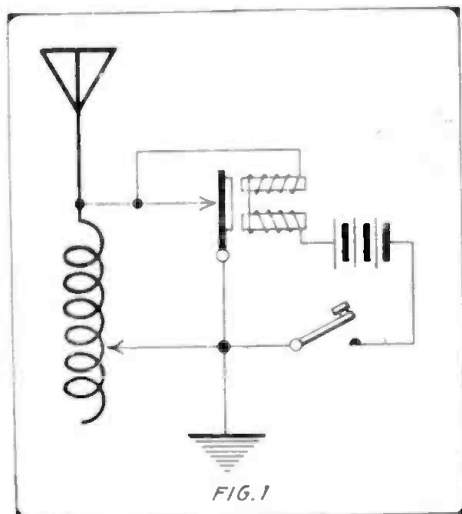

FIG. 1  
An Inductance Shunted Across a Buzzer Increases the Transmitting Range of the Set Considerably.

not great enough, and again, we could not vary the wavelength at will unless the antenna was constructed to suit the purpose. In what follows, a buzzer transmitter which is capable of variable tuning in respect to emitted waves is described. Also the amplitude is fourfold, making a record for exceptional distances with buzzers as a source of high frequency oscillations.

It was discovered that by shunting a buzzer with inductance and enough of same so that it does not form a short circuit as is shown in Fig. 1, the distance the same buzzer transmitted was four times as great. Furthermore, every time the inductance was varied, the pitch of the note was also changed and it was possible to transmit music by this new transmitter if suitable

keys and units of inductances were arranged.

In order to prove the above facts regarding the increased amplitude, measurements were conducted with the arrangements shown in Fig. 2. Here the buzzer was connected in the ordinary transmitting circuit (a) with a small inductance in the antenna lead to which the measuring apparatus was coupled. Then, as at (b) the inductance was shunted around the antenna and ground, or the vibrator contacts (proper). At (c) is shown the method which was actually used during the test; the inductance to be shunted was controlled by the switch S. Curves were derived from the actual results and Fig.

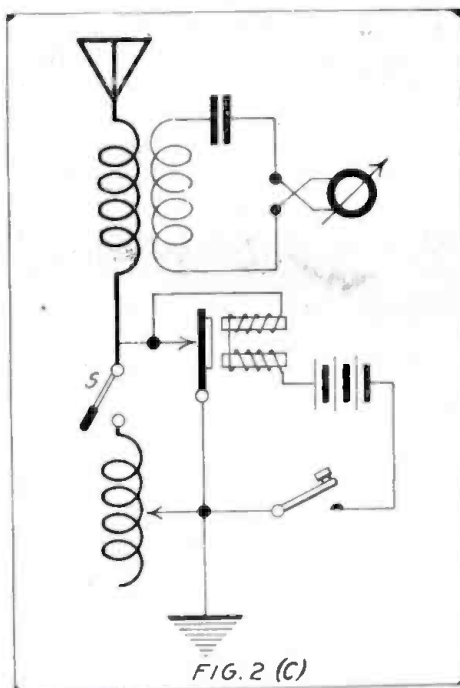

FIG. 2 (C)  
Here the Inductance Shunt Was Controlled by the Switch at S.

3 shows clearly the difference existing between the plain buzzer transmitter and one shunted by a suitable inductance. It clearly demonstrates the greater efficiency of the shunted buzzer type.

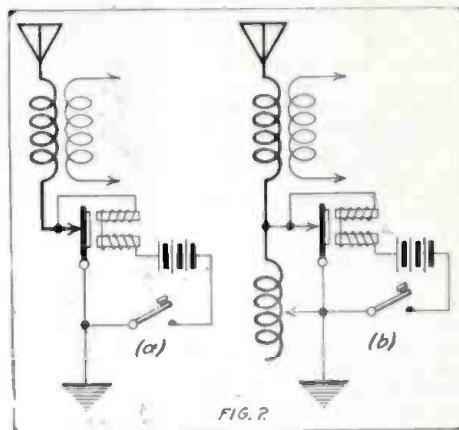

FIG. 2  
The Method Used for Obtaining Measurements in a Buzzer Transmitting Circuit as Shown in a. In (b) the Measurements Were Taken With an Inductance Shunted Across the Vibrator.

The circuit already shown is not just suitable for the correct operation of a transmitter and for this reason the one shown in Fig. 4 was developed which provides a means for tuning the antenna and employing the antenna and inductance unit as the shunt across the vibrator.

In order that the experimenter desiring to use this transmitter will not construct an antenna having a wavelength greater than 200 meters, details of the loop shown in the circuit Fig. 4 are as follows: Each strand is separated two feet apart, seventy feet long, and thirty feet high at both ends. This provides an antenna well under 200 meters, and considerable inductance can be added in the circuit to provide the shunt

(Continued on page 442)

## Using Tuning Coils and Loose Couplers in Panel Sets

The method here presented has been very successfully used by a few Massachusetts amateurs, and should prove useful to most all experimenters. The main thing in a panel set besides neatness and short leads, is rotary motion for varying the various inductances and capacities. In this method the slider control is changed to rotary by means of a small wooden disc, 6" in diameter, over and around which is a belt, made of strong and flexible cord, the ends of which are attached to the slider. This is shown in Fig. 1. The cord is first

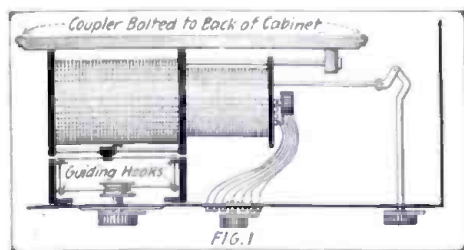

FIG. 1  
Here is Shown a Novel Method for Mounting a Loose Coupler in a Panel. Note the Slider is Controlled by a Knob, Also the Coupling.

tied to the slider and then continues thru two guiding hooks (or small pulleys) to the wooden disc, around the disc once so as not to slip and then continues back thru two opposite hooks to the slider where it is again tied. The cord is made fast to the disc at the one possible place. It will now be seen, that any movement of the disc will move the slider up or down.

The tuning coil is fastened to the back of the cabinet. The supports for the hooks are small, brass, right angle brackets secured to the panel. In all cases where a tuning coil is used as a loading coil, only one slider should be used. Where only one is used, we have only one possible dead-end, but when two or three sliders are used, we have two or three possible dead ends thus considerably lowering the efficiency. The disc used was 6 inches in diameter but this was only for a loading coil having a winding of 18 inches. With allowances for a little slipping, etc., the disc should be one-third the length of the winding.

The panel completed is shown in Fig. 2. A 180 degree scale should be used for the indicator.

The secondary has no slider but since it already has taps, a flexible conductor

may be soldered to each tap and connected to various points on a switch similar to the original one on the secondary. The wire used should be very flexible, the best being single conductor flexible silk covered cord of 16 or more strands of No. 32 wire. The wires from the taps should be bunched together and tied. If these are soldered and arranged carefully, they will last for years.

The regulation of the coupling may be controlled in two ways. One by direct sliding method and the other by rotary motion. The latter is perhaps the most

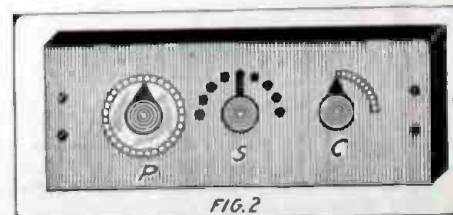

FIG. 2  
The Entire Loose Coupler Being Enclosed in the Cabinet Forms a Neat Appearing Instrument, as Shown.

# A New Receiving System

By EDWARD T. JONES, I. R. E.

**T**HERE are to-day numerous types of receiving units being employed to great advantage. Some make use of direct coupling, others static coupling and still others electro-magnetic coupling. This type which I designed and

be tuned slightly off-resonance making it possible to throw the interfering stations out further. The complete balancing circuit box is very unique in that it has but one connecting post from the tuned antenna circuit, and this circuit can be as far as is practicable from the antenna circuit, as it has no relation whatsoever as far as tuning is concerned. Once the primary or antenna tuning circuit is set to a certain wavelength it is not changed and therefore by bringing the secondary or balancing circuit to the same wavelength, maximum energy is abstracted.

The construction of this receiver is most simple. For the tuning inductance employed in the antenna circuit (see Fig. 4) an ordinary single slide tuner is employed. This can of course, be a unit of inductance controlled by unit-tens switches and the usual contact points. The latter is preferable due to the many objections which we have against sliders. However it is not absolutely necessary. Fig. 1 shows the complete tuning or balancing unit. Two coils are used as is seen in Fig. 5, however, it is necessary to cut one in half or wind two to equal the length of the longer coil. This is necessary in order to make the case as small as possible. Taps are taken off the two coils in units and tens. They are wound to lengths which satisfy the constructor. However for convenience sake it is suggested that they be of the following dimensions:  $4\frac{1}{2}$ " diameter by 8" long—winding. That makes the tuner 9 inches long, the two tubes 5 inches each with 4 inches of winding on each, tapt in the same manner as the larger tube. The tickler coil

the type shown is made fast to the top of the receiver where the two ends of the coils meet. This serves as a connection to the tuning antenna circuit.

Fig. 3 discloses the method of connecting the coils and the tickler coil to the binding

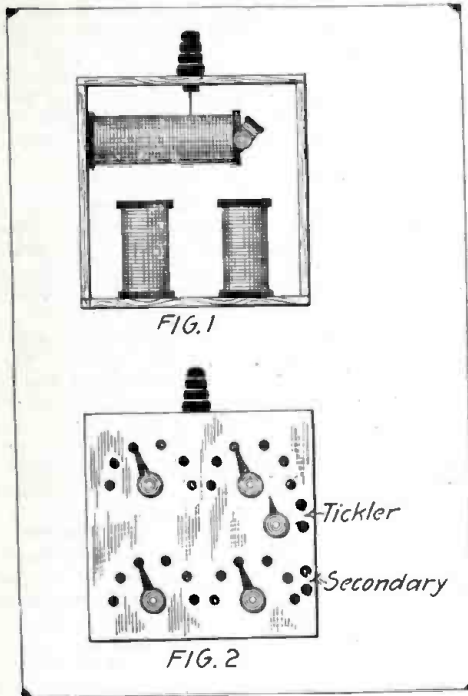
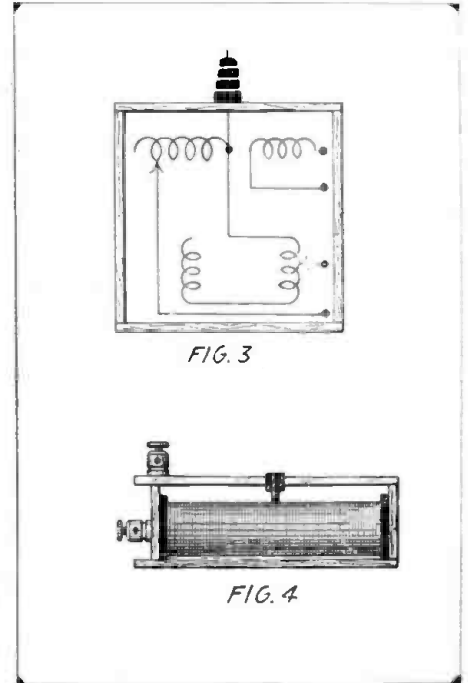

Fig. 1 Shows the Complete Tuning or Balancing Unit. In Fig. 2 Is Shown the Outside Arrangement of the Panel. Note the Large Insulator at the Top.



The Connections of the Inductances and Ticker Coil to the Binding Post Is Shown in Fig. 3. Figure 4 Shows the Antenna Tuning Inductances Employed.

advanced to the present stage of efficiency cannot be classed in the above. My system makes use of a tuned circuit, tuned in resonance, first to the passing waves which generate the feeble currents in the antenna; after this is done, the balancing circuit is cut in and this in turn is brought in resonance. There is but one connection or wire leading from the antenna circuit connecting the balancing circuit to the tuned antenna. This second circuit draws energy from the turned antenna circuit and signals in a much greater proportion than static. This makes for a receiving system which is highly desirable at places where statics are bad and where selectivity is most desirable.

This latter improvement is brought about by the following: The antenna can be tuned to one certain wavelength. This has a tendency, as in all such circuits, to minimize interference from other stations in that vicinity; and likewise the secondary circuit can be either adjusted to exact resonance with the tuned antenna circuit to abstract all the energy or it can

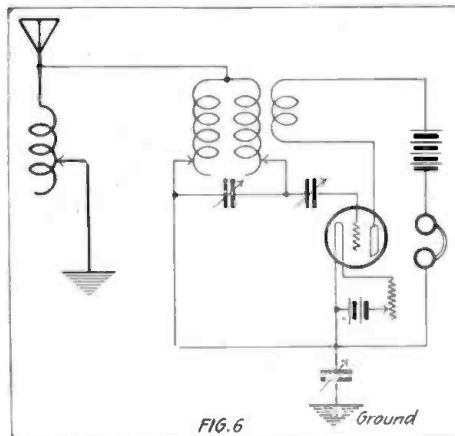

Greater Signal Strength Is Had by Connecting the Ground Lead Through the Variable Condenser, as Shown.

is placed in the end of the larger tube. This consists of a cardboard tube  $3\frac{3}{4}$ " in diameter by 1" wide wound with 150 turns No. 28 SCC magnet wire banked. The tickler is mounted and supported in the usual fashion similar to the moving coil of a variometer. The two leads from the tickler coil go to the binding posts marked "Tickler." These binding posts are connected in series with the plate of the audion and the "B" battery high voltage supply. Fig. 2 shows the outside panel of the receiver which is composed of  $\frac{1}{4}$ " Bakelite drilled according to the number of switches and contact points necessary. In this case, as shown there are four switches two of which have ten contact points and the other two enough to connect taps taken off every ten turns. The coils are wound with No. 24 SCC magnet wire. This permits a considerable number of taps being taken off and also a considerable wavelength range. To add to the appearance and its efficiency a medium size hard rubber insulator of

posts. It is seen that two ends of the coils are connected together and go to the insulated post connector as a common. The two remaining leads from the switch arms go to the binding posts marked "secondary." These lead to the audion or detector and phones.

Fig. 5 gives the circuit which proved most efficient in the operation of this receiving system. Here we see that the antenna connected to the single slide tuner terminates at the ground. From the antenna circuit or lead a wire or connection is run over to the balancing circuit and is connected to the (single) post protruding from the box. The connections which are evident are the usual ones employed in most regenerative circuits. The tickler is shown coupled to the coil which has its switch arm lead connected to the grid thru the usual variable condenser, this insures coupling between the plate and grid circuit and a constant feed-back according to the position of the tickler coil in relation to the larger coil.

(Continued on page 442)

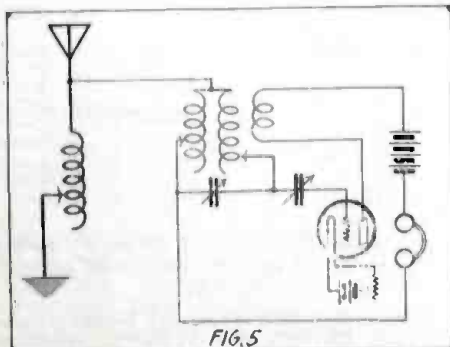

This Shows the Circuit of the Balancing System as Used with the Audion Detector.

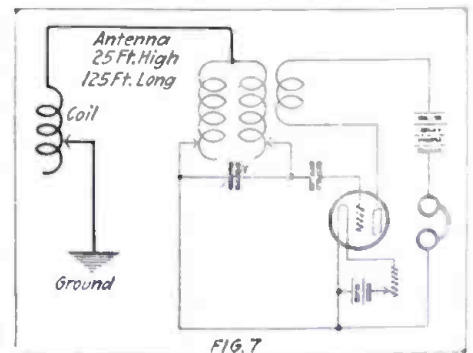

For the Elimination of Interference or Static, the Circuit Shown Here Is Very Efficient.

# A New Type of Condenser for Selective Tuning

By E. M. SARGENT

THE condenser here described is designed to work in circuits in which large values of inductance are used in conjunction with small capacities. It is especially suitable for regenerative work, as much sharper tuning can be obtained with it than with the ordinary semi-circular plate condenser. In order to best understand the working of this condenser it will be well to review some of the properties of oscillating circuits.

Curve (b), Fig. 1, shows a typical tuning curve of a coil and condenser of the size commonly used to receive 600 and 950 meter signals. It is a well known fact that the best signals in a receiving set are obtained with large inductances and small shunt condensers. The reason for this is that, other factors remaining the same, the voltage impress on the detector varies directly with the variation of inductance and inversely with the variation of capacity. As the signal produced by the detector in many cases varies as the square of the impress voltage, the result of changing the inductance is usually quite noticeable. In Fig. 1, the best combination for receiving 600 meter signals would be the one shown by curve (a). In this case  $L = 1200$  microhenries and  $C = .000084$  microfarads. 1200 m.h. is about as large a coil as is practicable to use for 600 meter work because, particularly if the coil is paraffined or shel-lacked and is tapt, the distributive capacity of the coil plus the capacity of the leads to the detector, the capacity of the condenser in zero position and the internal capacity of the detector will add up to about .000084 m.f., and it will not be possible to "get down" to 600 meters with a larger coil.

Referring again to Fig. 1, it will be seen that as  $L$  is increased from 800 m.h. to 1200 m.h. the tuning curve becomes steeper. In other words, when  $L = 1200$  m.h. the

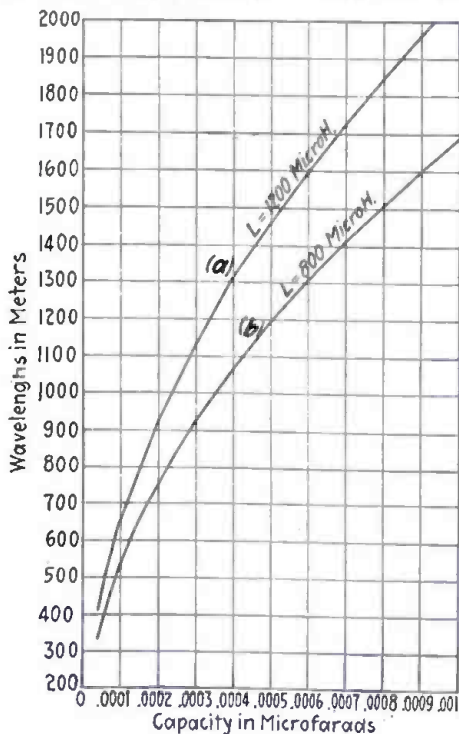

FIG. 1  
The Curve (a) Shows the Best Combination for Receiving 600-Meter Signals. A Typical Tuning Curve (b) of a Coil and Condenser of the Size Used to Receive 600 and 950-Meter Signals.

variation in wavelength with a small variation in capacity is greater than when  $L = 800$  m.h. As a particular example of this, take the change between the values  $C = .00000$  m.f. and  $.00007$  m.f. On the lower

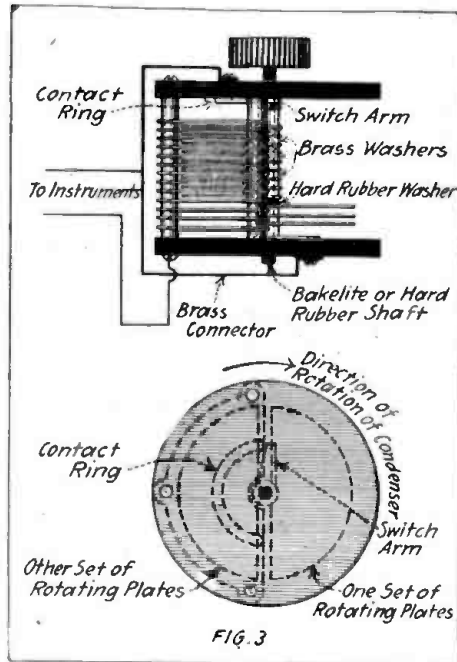

FIG. 3  
Showing the Construction of the New Condenser.

curve the wave length changes 72 meters between these points, while on the top curve the change is 90 meters or one and a quarter times as great. This, of course, means that the tuning with the 1200 m.h. coil is sharper than with the smaller one. An effect like this is to be expected, and might be predicted from the formula for

decrement,  $\delta = \pi R \sqrt{\frac{C}{L}}$ . In general  $R$  increases about half as fast as  $L$ , and as the wavelength is kept constant  $C$  decreases as  $L$  is increased. The formula may be re-written  $\delta = \frac{\pi R}{\sqrt{L}} \times \sqrt{C}$ , and assuming that  $\frac{\pi R}{\sqrt{L}}$  will remain nearly constant it will

be seen that  $\delta$  will decrease directly as the square root of the capacity. The decrement is the reciprocal of the sharpness of resonance, so as the capacity for a given wavelength is decreased the sharpness of resonance or sharpness of tuning will be correspondingly increased.

This effect is desirable in that it helps to eliminate interference, but as the decrement of the receiver becomes lower from added inductance the circuit becomes "stiffer" and accurate tuning is much more difficult.

There are many ways of getting around this difficulty. One is by means of a "square law" condenser which is so arranged that the capacity increases as the square of the angle of rotation of the movable plates. This has the effect of making the curves in Fig. 1 into straight lines passing thru the extremities of the curves drawn. The slope of the "curve" would thus be the average slope of the curve of a semi-circular condenser covering the

same range of capacities. Fig. 2 shows a curve of a square law condenser of maximum capacity .0075 m.f. Exact square law condensers are not available to the experimenter at the present time, altho condensers which approach this condition are on the market. However, condensers of this type are invariably more bulky than the semi-circular type and are for this reason undesirable for use in small cabinet sets.

Another means of getting selective tuning on the steep part of the curve is by using an additional movable plate controlled by an auxiliary knob. This, however, entails difficult mechanical construction and machine work beyond the means of the average experimenter.

A condenser which will give fine enough variation in capacity for all ordinary purposes, and which may be made from nearly any one of the many semi-circular plate condensers in common use is shown in Fig. 3. This condenser has 13 stationary and 12 rotating plates. With the rotating plates in the ordinary maximum position it would have a capacity of .001 m.f., but as arranged in the figure the capacity is only .0075 m.f. However, as the wavelength of a circuit varies as the square root of the capacity, this arrangement only reduces the maximum wavelength of the circuit by about one-eighth and the added convenience in tuning more than makes up for the loss of capacity. To convert an ordinary condenser into one of this type it is necessary to remove the metallic shaft on which the moving plates are assembled, and substitute a shaft of hard rubber, bakelite, or some other good insulating material. The washer between the two sets of rotating plates must also be an insulator. The only other necessary additions are

(Continued on page 440)

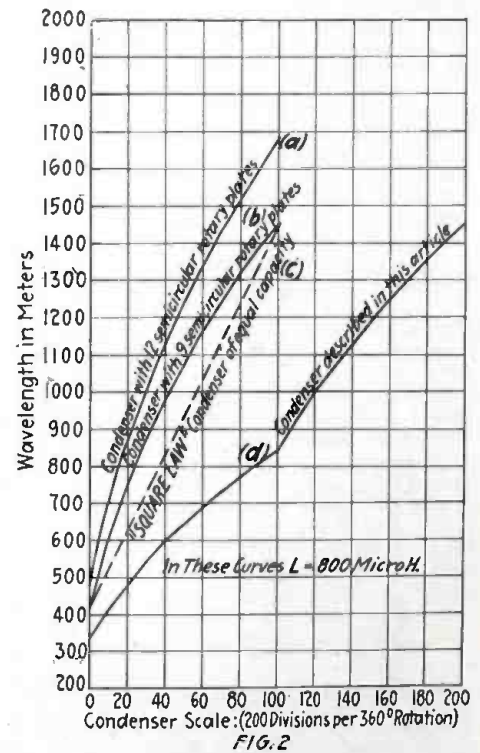

FIG. 2  
The Above Curves Show the Relative Comparison Between the Different Types of Various Condensers Used in Radio Work. Note the Curve (d) of the Condenser Used in This Article.

# A Step-Up Condenser

By JOHN G. MERNE, L.M.T.

County Technical Instructor, Leitrim, Ireland.

**R**ADIO experimenters who are on the lookout for something new in condensers will find this one a novelty among its kind as far as adjustment is concerned. The failings of many step-up condensers is the quantity of tin-foil required to obtain a certain capacity and the intermediate steps leading up to it. This has sometimes been obviated by the use of multi-pointed switches or other complicated means adopted that make certainty of contact a matter of doubt. In the condenser design the minimum number of sheets of tin-foil is used in the complete instrument to obtain the various capacities up to the maximum for which it is designed. The switch and contacts are so arranged that different combinations are utilized in order that the steps increase or decrease in consecutive order. The construction and operation of this switch is rather of a novel nature. All constructional details are shown in the drawings. The size and number of plates can vary according to the maker's ideas when constructing. By means of the one switch any number of plates can be put in or out of action. With a single switch as shown, the greatest number of plates that can be put in operation is 30.

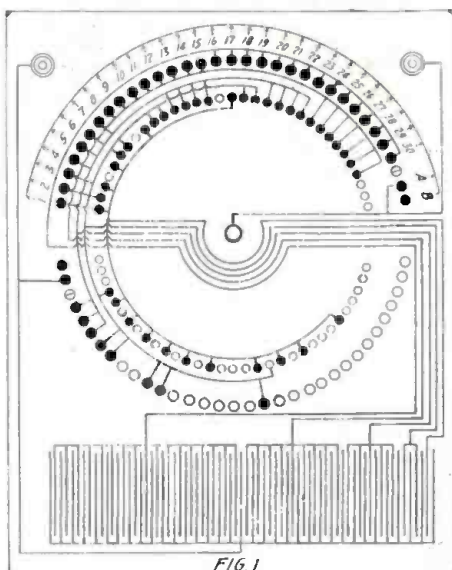

FIG. 1 The Method of Connecting the Condenser to the Various Contact Points Is Shown Here.

Fig. 1 shows the connections from the various studs. All studs in action are shown in black, the white ones are dead and are placed on panel, to enable the switch to move easily from one to the other. The action of the switch is explained as follows: Supposing one requires 5 plates in the circuit, switch points at five, joins outside stud which is connected to 4 plates and inside stud is connected to 1 plate. If 15 are required, then the outside stud is connected to 8 plates and the inside top stud to 4 plates with opposite studs on bottom of circle to 2 and 1 plates. This totals to 15. Example  $8+4+2+1=15$  plates. By this means any number from 1 plate to 31 plates can be connected. The stud after 30, with the line across it, is a stop over which, when the switch is at A, the positive and negative plates are connected and when at B the condenser is out altogether. The

condenser is shown connected up to the various studs. The drawings in Fig. 2 show the construction of the switch.

A shows the shape of the condenser plates which can be cut out of lead or tin-foil (size left to maker). B shows the shape of waxed tissue which should project at least  $\frac{3}{4}$ " all around the edges of plates, the other drawings show the construction of the condenser. The base which is circular has 6 blocks fastened to it, the spaces between enable the tabs of the condenser plates to pass thru. These tabs are then fastened to the edges of block as shown in the diagram by a screw and washer from which the connections to studs are made. The blocks enable the condenser plates to be in proper position, relative to each other and keep the whole set of plates and di-electric from moving. The height of these blocks depends on the number of plates forming the condenser. The cover is fastened on by means of 6 screws to these blocks at the same time it presses the condenser parts tightly together. When all parts are assembled and the cover loosely screwed onto its place, the whole block can be put into melted wax and kept there until all air is expelled. The cover

(Continued on page 445)

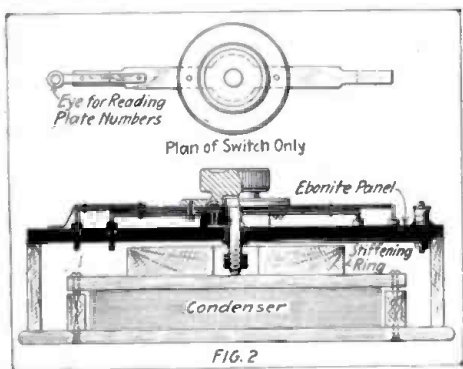

The Condenser and Switching Arrangement Is Mounted in a Cabinet, as Shown.

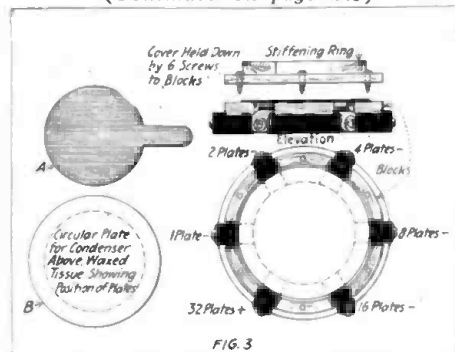

The Constructional Details of the Condenser. Note the Plates Are Circular in Form Which Makes Possible the Construction of a Compact Instrument.

# Honeycomb Inductance Coil Mounting

By C. J. FITCH

In the December issue of RADIO AMATEUR NEWS, Mr. C. R. Dunn described the construction of hand wound honeycomb coils. It is the purpose of this article to describe the construction of a simple and efficient device for mounting these coils. No taps should be provided on the coils when used with this mounting, as it is more simple and efficient to plug in different sizes of coils to cover the different ranges of wave-lengths than to use troublesome taps.

The accompanying drawing shows three coils mounted on a panel. One coil is shown in section for clearness. The two outside coils are hinged to the panel with small brass hinges as shown. This allows the coupling to be changed at will. The hinge is fastened to the hardwood block with wood

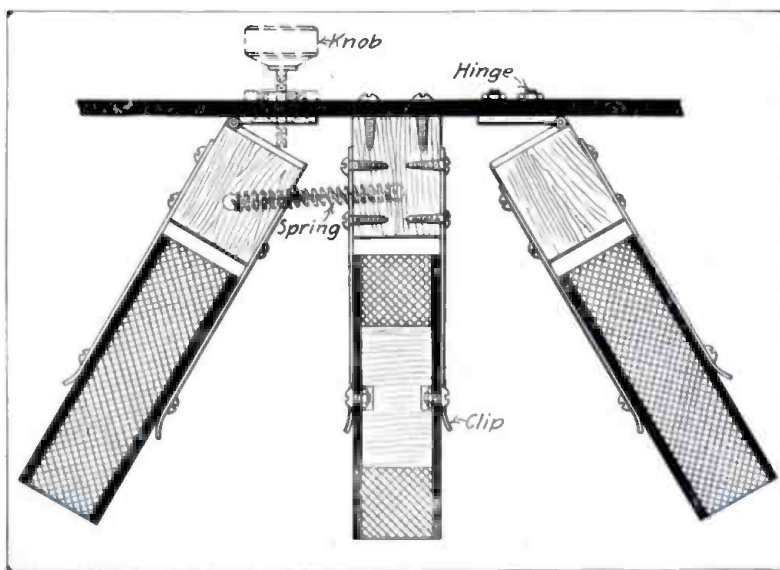

A Novel Method of Mounting Honeycomb Inductances. The Use of the Knob for Controlling the Coupling is Optional.

screws. The two phosphor bronze spring clips are fastened to the hardwood block with round head wood screws. Connection is made from these screws to the back of the panel with flexible cords. The phosphor bronze clip is  $4\frac{1}{4}$ " long x  $\frac{3}{4}$ " wide x .034" thick. A hole is drilled thru the clips in line with the center of the coil, so that the round head brass machine screw, which is located in the center of the coil, will snap into the hole when the coil is inserted in the clips. This holds the coil securely in place and also serves as a connection from the winding to the clips. The coil is protected on each side by a  $\frac{1}{8}$ " fiber disc. The diameter of the disc will depend upon the size of the coil. The disc is fastened to the hardwood case with three flat head brass wood screws.

(Continued on page 445)

**THE LATEST—A DOOR LOOP ANTENNA!**

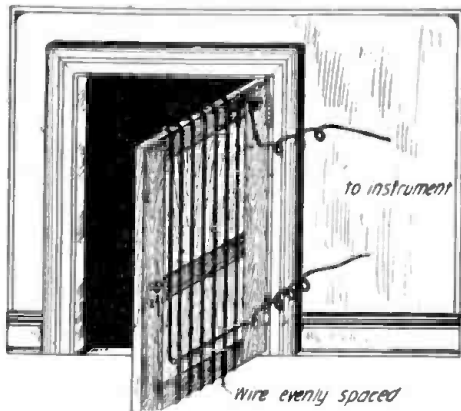

A Live Wire Amateur Discovered That a Few Turns of Wire Wound Around a Door as Shown Gave Excellent Results as a Loop Aerial.

I have read in the *Radio Amateur News* articles on how to make detectors from hairpins, insulators from pipe stems, etc., so I will take the liberty to add another common but useful article to the collection, namely the common or house variety of door. Wishing to try out a loop antenna with my receiving set, and not having the time to construct a frame for same, I hit upon the idea of winding the wire on the door as illustrated below. Not only did this serve the purpose of an indoor aerial but by rotating the door on its hinges direction-finder effects were obtained. In the future we may expect to find such phrases as this, "Wind one medium sized door with No. 22 DCC wire and solder leads to primary of loose-coupler." Yea, even the least of us shall be exalted.

Contributed by P. J. FAULKNER, JR.

**A NEW USE FOR THE FAN SWITCH.**

In practically all modern receiving sets that have tapped inductances, one of the several complicated types of "dead-end" switches is used to prevent the loss of energy and undesirable effects caused by the capacitance of the unused portion of the coil.

Most of these switches have extra contacts, used to connect and disconnect adjacent sections of the inductance, which are automatically opened and closed by the switch arm. This arrangement necessitates a specially wound coil, divided into sections and having twice as many taps as has the ordinary coil. This type of "dead-

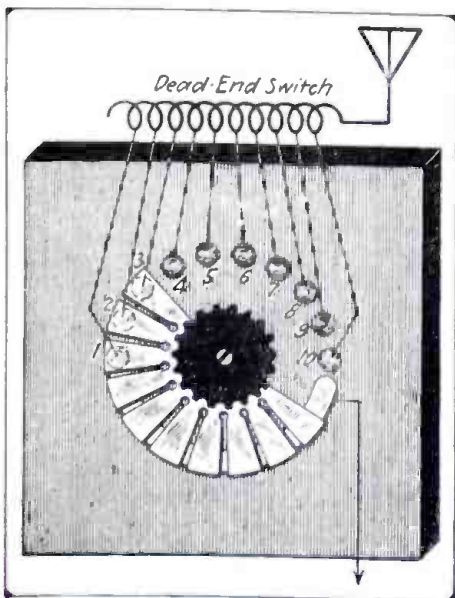

A Simple Dead-End Arrangement May Be Made by Using a Fan Switch of This Type.

end" switch not only takes up more space, but costs more than the ordinary switch.

While studying the cause and effect of the "dead-end" of an inductance, the writer chanced to think of the ordinary fan switch, such as is used with variable fixed condensers, as a solution of the problem. The taps from the coil are connected to the switch points as usual. As can be readily seen from the diagram, the contacts not covered by the "fan" represent the part of the inductance which is being used. Those contacts covered by the "fan" represent the "dead-end" of the coil, and there can't possibly be any capacitive effect because that section of the winding is short-circuited by the "fan."

This method of eliminating the "dead-end" effects is very simple, yet it accomplishes its purpose in a thoroughly satisfactory manner.

Contributed by D. W. RUBIDGE.

**HONEYCOMB COIL RACK.**

In these days when honeycomb coils and similar inductances are piled up high on the amateur's table, very few of the experimenters attempt to construct some form of contrivance for mounting the coils when not in use. In every station, even first-class ones, I have noticed the coils lying around in piles of twos and threes. Common sense will tell you that such usage causes considerable wear on the insulation of the wire in the coils. To hang the coils up on a nail is just as bad, for they are subject to falling off.

A rack for honeycomb coils which has

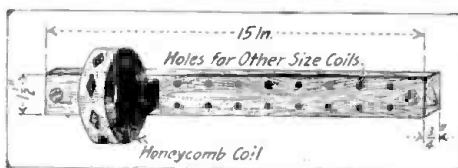

A Simple Honeycomb Coil Rack, Which is Excellent for Holding Unused Coils.

its many advantages is shown in the illustration. An ordinary strip of wood, or if the amateur prefers bakelite, is obtained and cut to the dimensions shown. By drilling holes in this strip of a sufficient size so that the coil plugs may be inserted. Fasten this rack to a convenient place at the rear of the table with two screws, one at each end of the rack. Now your entire group of coils may be plugged into this rack, and when you desire to use any of the coils, you will have little trouble in finding them, and at the same time, they will be out of the way of sharp corners, edges and so forth, which produce short circuits.

Contributed by W. A. HEPPNER.

**AN EASILY MADE GRID LEAK.**

At the druggist's, get a small tin box in which cold cream, etc., is usually sold. It should be about an inch in diameter and  $\frac{3}{8}$  of an inch high. From any kind of  $\frac{3}{16}$  inch insulating material you have, cut a piece to fit tightly inside the box. Draw a diameter and  $\frac{5}{16}$  of an inch from its ends, drill holes to pass 6-32 around head brass screws. Drill right thru the bottom of the box, remove the inside piece, and then enlarge the holes in the bottom so that the screws will not be short-circuited by the metal.

Replace the insulating piece and then cut a piece of clean white paper to fit over it. Push thru the holes. Around them mark heavy pencil lines, so that the screws can make connection with the pencil lines forming the leak itself. The correct value of these last lines is found by experiment, the complete leak having first been mounted by drilling two holes in the panel, or wherever the reader wants to put it, pulling the screws thru, and then tightening at the back by nuts. Connections are taken, of course, from these same screws.

To find the proper value of resistance is not as hard as some thing. It takes in fact, only a few minutes. After obtaining it,

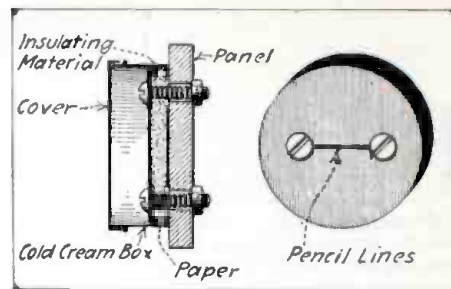

This Shows the Method of Constructing an Enclosed Type of Grid Leak.

press on the cover of the box, and leave it on.

Contributed by ROBERT H. ERTZBERG.

**RHEOSTAT OF NOVEL CONSTRUCTION.**

This rheostat consists of two different lengths of resistance wire so arranged that they are controlled by two switch knobs on one mounting. A very fine adjustment can be had, and should therefore be of use to many amateurs.

The resistance is wound on two asbestos or fibre discs ("A" being 3" in dia. and "B"  $2\frac{1}{2}$ " in dia.). Both discs are about  $\frac{1}{4}$ " thick. In the centre of each disc an  $\frac{8}{32}$ " hole is drilled. Disc "A" is wound on the outer edge with resistance wire in the form of a coil. The two ends should not meet but should be fastened as shown in Fig. 1. The small disc holds a single strand of wire secured in the same manner. A small spring (E) of spring brass is mounted on "B" so as to make contact with the wire on "A." Another spring (D) is attached to the cabinet to make contact with the wire on "B." A copper strip (C), 5" by  $\frac{1}{2}$ " is drilled at each end and bent as shown. The small knob "G" is 1" x  $\frac{1}{4}$ " and has an  $\frac{8}{32}$ " hole drilled in the center. The knob "F" is  $1\frac{1}{2}$ " x  $\frac{1}{4}$ " drilled with a somewhat longer hole so as to turn freely. A small spool is cut to the required length and fastened to the large disc with glue. A bolt 2" x  $\frac{8}{32}$ ", a few washers and four nuts are all that are required to finish the instrument. The springs are connected as shown in the drawing.

Turn the large knob until sufficient resistance is in series. By turning the small knob a very fine adjustment is possible.

Contributed by RAYMOND LISTER.

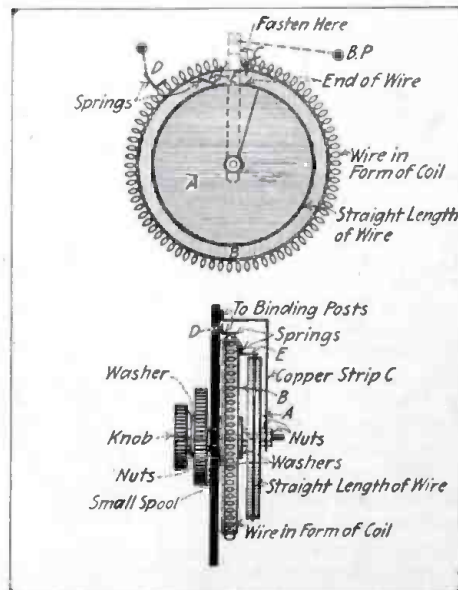

The Rheostat Here Shown Permits a Very Critical Adjustment.



# “Ideas”—Third Spasm

By THOMAS W. BENSON

**A** GAIN we will stroll among the high-ways and byways of the Radio art in search of some little thing which will benefit mankind or at least be food for a few minutes or hours of thought. Seems to me a lot of us do too much fooling around and too little thinking nowadays.

Take the old galena detector. Great thing in its day, what! Remember when you picked up—but never mind, you'll pardon an old Romancer for it seems tame along side the stuff we now do with the two stage amplifiers and regenerative sets that pound the “stuff” out like the report of a thirteen inch trench mortar.

And we did things to that detector, we sealed, exhausted, gassed, oiled and heaven knows what not to them. Can you say offhand, that at some critical temperature, that old galena, or even silicon, iron pyrites or carborundum won't bark the signals? Try it.

Wrap a strip of mica and then a few feet of fine iron or German-silver wire around the detector cup, connect it to a storage battery and a rheostat. Connect the detector to the set and tune in some press stuff. While the message is being copied, start heating the crystal cup by turning current into the resistance wire keeping tabs on the signal strength—“No thanks, really it's quite impossible for me to accept more than this check for 10,000 dollars. Modesty forbids, y'know.”

Hold on now, maybe the critical point is below the normal temperature of your operating room. Perhaps that is why such good work is done in the Winter. Go ahead and laugh, but watch out, some fellow might suddenly draw your attention to the fact that it works. So try cooling the detector by placing it on a can containing ice and listen for changes in signal strength.

And a still stranger thing about crystal detectors not generally known. Take any pair of contacts comprising a detector, a

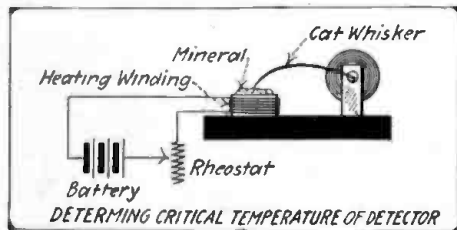

On Cold Winter Days There Is Nothing Like Providing a Little Heating Arrangement for the Ever-Delicate Crystal—Try It.

steel wire and silicon, plumbago and galena, gold and iron pyrites, copper and molybdenum, zincite and chalcopyrite (perikon), being some of the regularly used detector

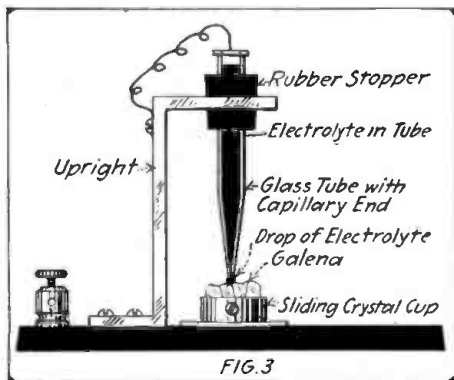

Ye Editor Used a Drop of Electrolyte. For a Contact on a Crystal of—Galena.

elements at one time. It will be found that one of the contacts is photo-electric, the other not photo-electric.

A photo-electric substance, by the way, is one that throws off negative charges under the influence of ultra-violet light and almost without exception two substances that form a detector of radio waves differ in their photo-electric properties.

Has this any bearing on the efficiency of the detector? It might be worth while to try.

As stated above, a photo-electric body throws off electrons under the influence of light, the quantity not being dependent upon the intensity of the light but on the wave-length—that is with the color. Perhaps by allowing a certain colored ray of light to fall on the crystal it will become wonderfully sensitive.

Conceive then of the detector of the future, the usual mounting but above the crystal cup is mounted a tiny round box with a lens directed at the crystal. Inside the box is a miniature incandescent lamp, a transparent drum around the light being adjustable by a knob on the exterior. The drum is striped with all the colors of the rainbow. When the light is switched on and the knob turned, one color after the other is thrown upon the crystal by the lens. It's not beyond reason that it will work, so go ahead and try it.

Excuse me now, old dear, I must take the dog out for his Promenade d'Après-midi and get some sewing silk for the other

three-fourths of the corporation.

(While this bird is out lending an air of dignity and beauty to the scenery of his surroundings, we want to say that you amateurs who attempt to soothe the old crystal with hot water bags and cold water applications, or massage its joints with camphorated liniments, might find a hidden future. But when it comes to photo-electric dope we are way ahead of this impulse agitator. Why not direct a tiny beam of light against the Hon. crystal; connect one end of the beam to the receiver and use the other end as a contact point! As is well known today a beam of light is a conductor of H. F. oscillations therefore—we'll now try your different colors. 10,000 dollars—bah!

Then—oh—sh—here's a real secret. Some years ago ye editor experimented with a hybrid crystal-electrolytic detector. See Fig. 3. Instead of a catwhisker he used a very small drop of electrolyte which exuded from a capillary tube, see sketch. The rubber stopper was used to adjust the movement of the tube. A platinum or other fine wire connected the solution with one binding post. The detector cup slid back and forward, so that any point of the crystal could be explored. And it works. With Galena, strong acids can not be used, as they destroy the crystal. But the writer found salt solutions very efficient. With some solutions a battery proved of great help, giving extraordinary sensitiveness.

Unfortunately ye Editor just then went into the magazine business and completely forgot to terminate the experiments, and to take out patents on the idea.

Won't some kind soul therefore take up the work where ye Editor left it, and tell him what success he has with the idea?

Note that the electrolytic drop must be very small. Advantages: Detector can not be knocked out; will stay sensitive for days. Sensitiveness with certain solutions, greater than best galena-catwhisker detector. Editor.)

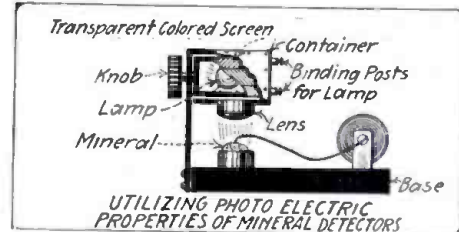

Behold the Crystal Detector of the Future, in the Limelight, as it Were.

## They All Come Back!

By EDWARD F. McMAHON

I'll say so!  
I'll tell the world!  
You can take it from me.  
I know.  
“And what in heck is he raving about?”  
I suppose you, gentle reader, are asking yourself.

Patience! Let not anxiety plow furrows in your noble brow. For I rave of the lure of the wireless.

You can swear off tobacco, friend. You can take a Keeley or any other cure to sidetrack the demon rum (only you won't need to now that Uncle Sam has stepped up with the best cure of all, the water wagon).

But can you swear off fooling around a few coils of wire, a safety pin resting on a

bit of lead ore, and a few other of the miscellanies that comprise a “Ham” wireless set in embryo?

Oh, sure you can! You can swear off once, twice and thrice, but eventually you will fall for the count. Just twice I swore off, but the third time got me, and, as the saying goes, got me good.

The first time I became interested in radio, my natural inborn laziness prevented me from putting the necessary effort into learning the code. So I packed my set away, pulled down my aerial, and said “Never again—too much like work.”

About three months later I was visiting out of town and met a young fellow who had made most of his set and was getting results. He got another result. The result

was that I went home and dug out my set once more and did some real earnest work with it for about four months.

Then came a new car, with the result that I spent so much time with that I forgot all about the existence of my wireless set. And then came the big scrap, which meant parting with the set for a good long time.

Long after the war had ended and the amateur restrictions had been lifted I let the old set lay in the attic, whence I had relegated it. And then one day I saw a new magazine adorning the news-stands, RADIO AMATEUR NEWS.

“Ah!” said I, “a new one,” and purchased a copy. A short glance at the cover (Continued on page 444)

# RADIO DIGEST

## VACUUM TUBES.

H. J. van der Bijl, M.A., Ph.D., in his article on vacuum tubes, discusses in detail every type of vacuum tube manufactured since its discovery. All kinds of various tubes are illustrated. The author also describes in detail the operation of the vacuum tube. Here is what he says in a part concerning the Western Electric Tube:

"Tubes made by the Western Electric Company contain the oxide coated type of filament. These must never be operated at high incandescence. In fact, the temperature must never be raised to more than a yellowish red, because it only shortens the life of the tube and contributes nothing to increasing its sensitiveness. The coated type of filament emits electrons more easily than tungsten and will therefore give the same thermionic current at a low temperature."

In another article on this subject a great many types of vacuum tubes are shown together with a tabular list which gives detailed information relative to the tube such as the origin, construction and where used.—*Abstracted from February issue of "Popular Science."*

## RADIO PANEL UNITS.

M. B. Sleeper has some new and original ideas regarding the use of unit panel transmitting and receiving apparatus. A complete radiophone set, for instance, is constructed of these panels, each having mounted thereon an instrument necessary for the proper functioning of the set.

A novel departure from the usual dial mounting is incorporated in this set. The dial itself is mounted directly to the face of the panel while the pointer is fastened to the knob. An advantage is that readings may be taken from left to right instead of counter-clockwise. By using a large dial and knob, such as may be had in the market today, a very neat effect is produced.—*Abstracted from January Everyday Engineering.*

## THE DEVELOPMENT OF ARC RADIO TRANSMITTERS.

By A. L. ANDERSON and H. F. ELLIOTT.

A general description is given of the types of arc apparatus manufactured by the Federal Telegraph Company, with illustrations of a 5-kw. and a 200-kw. arc. The usual sizes that are manufactured are 5, 20, 30, 60, 100, 200, 350, 500, and 1,000 kw., the rating being reckoned on the D.C. input. The efficiencies of these sets range between 33 per cent. and 50 per cent. For ship work sizes up to 30 kw. are customarily used with wavelengths between 1,000 and 5,000 meters; while the larger sizes are reserved for large land stations, working on wavelengths of 2,000 to 15,000 meters. The arcs are joined directly in the aerial circuit, and are usually fed with direct current at 500 to 600 volts. For the smaller arcs alcohol is usually employed to provide the hydrocarbon atmosphere; but in the larger sizes and to obtain considerable power on short wavelengths, kerosene is used. This material increases the aerial current when the magnetic field is weak, but is apt to give a deposit of soot in the arc chamber. Coal gas is preferable.

Three types of signalling arrangements are described: (1) the compensation method, in which the signalling key short-circuits a few turns of the aerial inductance; (2) the coupled compensation method, in which the key short-circuits a small loop coupled to the aerial inductance; and (3) the ignition key signalling system, in which the arc is mechanically short-circuited through a

resistance between the signalling periods. The second method is the most preferable; with small powers (5 kw.) one loop and short circuiting key is used, for larger sizes several loops are employed, each fitted with an electro-magnetically operated short-circuiting key. For a 100-kw. arc twelve such loops and keys are required. The third method is only suitable for very small power units.—*Abstracted from Aug. Electrical World.*

## TO OUR READERS

Beginning with this issue, it becomes necessary to advance the price of RADIO AMATEUR NEWS to 20c a copy, \$2.00 a year in U. S. and \$2.50 a year in Canada and foreign.

It's against our policy to raise the price, because it isn't good business for us. There is also the bare possibility that doing so may check our phenomenal growth; RADIO AMATEUR NEWS today prints more copies than all of the other Radio Journals COMBINED.

But a moment's consideration will show you that we couldn't do anything else and remain in business. The price of paper has increased 40% over the price in 1918. The cost of printing has gone up 35% and is going higher. Engravings and art work have increased over 50%. Salaries have advanced more than 40%.

In raising the price to 20c we only ask you to shoulder a small percentage of what we have had to stand for. The advertiser is paying several times the increase in price you are asked to pay. Also don't forget that we have added over 16 pages to the magazine or one-third more pages than we started with.

We cannot publish at a loss and we will not print a 48-page magazine, such as we started with now, after having built up the greatest radio magazine in the world, in point of size as well as circulation. And some day we dream of 200,000 copies for RADIO AMATEUR NEWS, but this cannot be accomplished unless we can go ahead without losing money. And the bigger the circulation becomes, the more advertisers will pay for their ads and the more pages we can add to the magazine for you.

When conditions are normal once more we expect to come down to the former popular price. Until then we ask you to be patient with us. Remember our profits are less; in fact, much less than when the former conditions prevailed.

## NEW RADIOPHONE MODULATOR.

A new means of modulating radio frequency currents has been devised by Dr. Lee de Forest. In the past, the greatest difficulty encountered in voice modulation, has been the small magnitude of the modulated currents when an ordinary telephone microphone was used.

Dr. de Forest's invention is based upon the following:

If a portion of the inductance which is used in the antenna circuit is shunted by the microphone, and the microphone is actuated by the sound vibrations produced by the voice, the wave length of the transmitted energy will be varied in accordance with the various voice vibrations.

If each of several consecutive turns of the inductance are shunted by a microphone, it will be easily seen that a considerable effect upon the wavelength of the transmitter may be produced.—*Abstracted from December Wireless Age.*

## RADIO ANTENNAE.

The amateur transmitting antenna using the 200-meter transmitter should be one whose height plus its length does not exceed 90 to 110 feet, made up of four wires placed three feet apart with a lead-in taken off the center or end.

For all practical purposes, the receiving antenna may consist of a single wire of a length great in comparison to the height.

A well-known radio apparatus company has standardized on three sizes, called short, long and super-range, being approximately 100, 200 and 300 feet long. The elevation should be approximately 30 feet at each end. The low expense and extreme simplicity, combined with high efficiency, has made the single-wire antenna very popular for long-distance reception. As much loading as desired, either with condensers or inductances, can be used with a receiving antenna. Mica condensers, or those using anything but air dielectric, are not suitable for oscillating receiving circuits. A condenser shunted around the tuning inductance is very efficient, but it must not have any considerable losses. The leaky condenser across the coil is as bad as a resistance shunted around it.

For transmission, the loop antenna which is efficient on 200-meter work, should be from four to six feet square.

Another type of antenna worthy of mention is the condenser antenna. This may be made of two squares of copper netting six feet aside, and one foot apart, suspended horizontally so that the upper plate will be one or more feet from the ceiling. For transmitting, this produces exceptional results. There is a large field for development of the condenser antenna for receiving.—*Abstracted from January Everyday Engineering.*

## TEXT BOOK ON WIRELESS TELEGRAPHY.

By RUPERT STANLEY.

Two volumes, 825 pages, profusely illustrated, cloth bound, size 6 x 9 inches. Published by Longmans, Green & Co., New York City.

The main fault to be found with treatises on radio telegraphy is that they deal with theoretical conditions in a manner which can be thoroly understood only by those who have already become acquainted with the theory of electrical science and the technical terms used in connection with the same. In Volume 1 of his new text book on "Wire Telegraphy," Rupert Stanley, B.A., M.I.E.E., covers in a thoro and easily understandable manner the theory and operation of radio apparatus.

In the opening chapters the author has introduced the radio telegraphy by demonstrating its place in the natural order of things and its intimate relation to other branches of science. The electron theory is used thruout the book. Dealing with the technical portion of the subject, the calculation and formulæ have been made as simple as possible.

At present there are very few books on the market which deal entirely with the subject of vacuum tubes or valves, as they are known. Of course, many publications have dwelt upon the theory of the vacuum tube in general, but few have clearly and systematically explained the operation of all classes and types of vacuum tubes of the latest design.

In his second volume, Rupert Stanley has kept in mind these various points, and has succeeded in placing before the public a complete and authoritative treatise on vacuum valves, including theory, operation, problems, circuits, characteristics and everything connected with the same.

(Continued on page 447)

# \$100 RADIOPHONE PRIZE CONTEST

ONE of the most disappointing features of Radio Amateur Progress at present is the seeming lack of interest in the Radiophone.

The Editor of this publication has always taken the stand that the ultimate goal for all radio enthusiasts lies, without a shade of doubt, in radio telephony.

The reasons are so obvious and so convincing; while not one single argument can be found against it. Radio telephony is the one and only solution out of all the many Radio amateur's troubles, to wit:

With Radio Telephony, interference with Government and Commercial stations is practically done away with at one stroke. Consequently and logically, the radio amateur will at once be placed in a safe and dignified position. He will not be bothered as in the past and present with anti-amateur legislation. *But American radio amateurism will surely perish if its future rests upon radio telegraphy.*

With Radio Telephony no codes need be mastered. You talk, that's all.

With Radio Telephony, the length of time required to send a message is from 1/10 to 1/20 shorter. Consequently more traffic can go on for a given time than now.

With Radio Telephony, the turning is infinitely sharper and better, consequently less interference. With Radio Telephony, radio amateurism will become truly great—of a national scope. Where there is one radio amateur telegrapher today, one hundred will grow in his stead the moment practical radio telephony is here. Everyone will use the radiophone! The farmer, the business man, country folks, motorboats, autos, etc., etc.

Now the curious and surprising thing is that the radiophone has been with us for some years past. There is nothing new about it, no secrets, no patents that need bother any amateur. Then why don't we use this wonderful invention to the very limit? It will surely hooom Radio Amateurism more than any one thing in this world ever can or will. We have all the tools, so where is the hitch?

Now, the Publishers believe in the truly wonderful future of the Radio Telephone. They will stake their reputation—nay, if necessary, their all—on their conviction. They will spare no expense, leave no stone unturned, to make American Radio Amateurism one of the world's greatest institutions. And Radio Amateur Telephony will be the keystone to this edifice.

With this in mind the Publishers wish to bring out the best from the ranks of our amateurs, the best being of course radio telephone transmitting instruments. Any modern radio receiver is capable of receiving either radio telegraph or radio 'phone messages. We are concerned here, only with the instruments that send the messages.

## PRIZES OF \$100 IN GOLD

|                        |         |
|------------------------|---------|
| First Prize . . . . .  | \$50.00 |
| Second Prize . . . . . | 25.00   |
| Third Prize . . . . .  | 15.00   |
| Fourth Prize . . . . . | 10.00   |

The Publishers therefore offer prizes of \$100 in gold for the best articles on a practical radio telephone outfit. America's foremost radio experts will act as judges of this contest. As every one of the judges will pass upon the manuscripts submitted there can be little doubt that all contestants will be treated fair and impartial. Furthermore, we feel certain that this contest will not only bring out the very best there is in the American amateur, but that it will lift the new art to an unknown and undreamt of level.

Here are the men who will act as the judges of the contest. A distinguished array of the best radio talent in America:

Dr. Lee de Forest, Ph.D., Inventor of the Audion.  
 Dr. Greenleaf W. Packard, Inventor of the Crystal Detector.  
 Dr. Louis Cohen, Ph.D., Radio Expert and Inventor.  
 Fritz Lowenstein, Radio Expert.

H. W. Secor, Assoc. I. R. E., Associate Editor, Electrical Experimenter.

H. Gernsback, Editor, Electrical Experimenter and Radio Amateur News.

## RULES OF THE PRIZE CONTEST.

The set to be described may be of the vacuum tube type, the arc type, the quenched or other spark type. Or it may have embodied in it new features not known at present. The important part is that the set must have been actually built, that it either is in use now or has been in use. "Ideas" or patent descriptions are strictly excluded from this contest. It is also obvious that, insofar as this contest is conducted chiefly to bring out NEW ideas, commercial radio telephone outfits, as now sold by several makers, are excluded from the contest.

It is necessary to state what instruments are used, and if certain instruments have been bought, the make must be stated. The transmitting distance of the radio-telephone should be given, i. e. the record distance covered with the set. A complete diagram of connections, neatly executed in ink, is to be furnished. A good photograph (not smaller than 5 x 7") giving at least two views of the set is necessary. A photograph of the builder is required.

The sizes and the kind of wire used in the construction must be given, as well as the dimensions of the principal parts. More than one outfit may be entered by a contestant. The contest is open to every one (radio clubs included), except manufacturers of wireless apparatus. The manuscript should not be longer than 1,500 words. 1,000 words are preferred. All prizes will be paid upon publication.

The contest closes in New York April 12th, and the first prize-winning article will appear in May, 1920.

Address all manuscripts, photos, etc., to "Editor Radiophone Prize Contest," care of this publication.

## The Experimenter in Australia

[Mr. F. Charles Jones, the writer of this very interesting letter, is a Warrant Officer Instructor in the Regular Army. He advances a novel idea—an American-Australasian Radio Association. Indeed, why not? We would strongly advise some Western Radio Club to take up the matter seriously. Mr. Jones no doubt would do his part. Then the two clubs could, by correspondence first, check up certain calls, etc. Later, perhaps, as the art advances, real trans-Pacific sending can be done. This journal shall be happy to help the movement along. Who will make the start?—Editor.]

The restrictions hitherto existing in Australia have now, to a certain extent, been lifted. Experimenters are granted permission to "carry on" if the authorities are satisfied that their intention is an earnest one and likely to bring about improvements in radio. The permit issued is for receiving only and the use of valves limited to special cases. No transmitting is yet permitted.

Luckily our director of wireless telegraphy, himself an ardent experimenter, is sympathetic, and experimenters are relying upon him to obtain a fair deal for them.

We Antipodeans are scarcely heard of, and to see any mention of us in any part of the wireless world is indeed rare. In contrast to this I might mention that the Australian experimenter takes things very seriously, the average knowledge of the subject is very good and some of the stations in use before the war would hold their own with any I have heard described overseas. Further, a deep interest is taken in the subject as regards other parts of

the world, and wireless associations and stations are all noted and entered in our records.

In this respect we owe much to our esteemed friend and counsellor the *Electrical Experimenter*. In the early days of wireless, *Modern Electrics* was the only literature obtainable on this subject in Australia. Its appearance each month was looked forward to with an expectation that only an experimenter in search of knowledge can appreciate. Its descendants, the *Electrical Experimenter* and now *Radio Amateur News*, have inherited the popularity gained by its predecessor and, despite difficulties of transport and censor restrictions, we managed to procure copies all through the late war.

The Australian is really and truly a marooned race, that is, scientifically. It takes about three months to get anything from Europe or the U. S. A. Cables are always congested and in the case of a break where would we be? Now is the time for everyone concerned to place radio on a footing that will not allow the thing to become a private monopoly or even a government one. Further, its advancement so far has been hampered by an unfortunate principle that has always existed amongst us Britishers, that is, keeping science a mystery; this has never given the unlettered man a chance. Yet the greatest, the most useful, the most beneficial inventions have emanated from unlettered men.

This prejudice has now, happily, almost ceased to exist and science is beginning to assert itself as democratic and no longer confined to a narrow minded circle of pedants.

Good work has been done in the past by the wireless experimenter in Australia, and some record long distance receiving has been achieved. Speaking for myself, I remember way back in 1912, listening in on New Year's eve to catch a pal on a boat, hearing M.Q.I. of Macquarie Island right down south with the Antarctic Expedition. I had a friend in the "room" at the time (he has since paid the great price in France), who took down the message word for word. It was what we call a "D D" message out here, that is to say, it is repeated several times, as the sender does not expect to receive any reply, for in those days no Australian station could send that far.

The official station in Sydney did not hear the message, neither did any of the company outfits on the steamers. The result was that my statement, as well as a score of other experimenters' who had got it were publicly denied. Some days later it was again sent out and this time the official stations got it. The experimenter smiled.

It is the old, old story; a well equipped experimental station with every conceivable form of detector and tuning apparatus, backed up with heaps of enthusiasm, against a hidebound crude system then in vogue. The same thing occurred about two years later. One night eight private stations picked up Jask Persia and copied it clearly; it was speaking to a boat in the Mediterranean on its way to Australia. This was also denied with a certain amount of ridicule owing to the extreme distance. A month later we had documentary evi-

(Continued on page 439)



**T**HIS department is open to all readers. It matters not whether subscribers or not. All photos are judged for best arrangement and efficiency of the apparatus, neatness of connections and general appearance. In order to increase the interest in this department, we make it a rule not to publish photographs of stations unaccompanied by a picture of the owner.

We prefer dark photos to light ones. The prize winning pictures must be on prints not smaller than 5 x 7". We cannot reproduce pictures smaller than 3½ x 3½". All pictures must bear name and address written in ink on the back. A letter of not less than 100 words giving full description of the station, aerial equipment, etc., must accompany the pictures.

**PRIZES:** One first monthly prize of \$5.00. All other pictures published will be paid for at the rate of \$2.00.

## Frank Frimmerman's Station

Ten months ago I knew very little of the radio art. It was during the war that I first became interested in this alluring game. Due to the fact that the restrictions on the operation of amateur stations were in force during that period, I was unable to carry out the experiments which I had read about. I was interested enough, however, to continue studying and by the time the ban on receiving stations was lifted I was prepared for it.

At first I started in by experimenting

with small instruments. Once started I succeeded in getting in touch with a few amateurs. I soon learned that my book knowledge amounted to very little when it came to putting the same into practice. There were so many designs and makes of apparatus on the market that when I plunged into the game in real earnest I couldn't make up my mind as to the proper apparatus to select. I finally decided upon the honeycomb coil system and before many days had past I formed my plans for

constructing a receiving set of my own design.

While waiting for condensers, sockets, etc., I erected the aeriels. At present I have two aeriels, one being used for short waves and the other for long wave reception. The short wave aerial consists of four No. 14 stranded phosphor-bronze wires about 50 feet long. The large aerial is approximately 250 feet long and in construction is similar to the short aerial. In order to offset any induction effect the

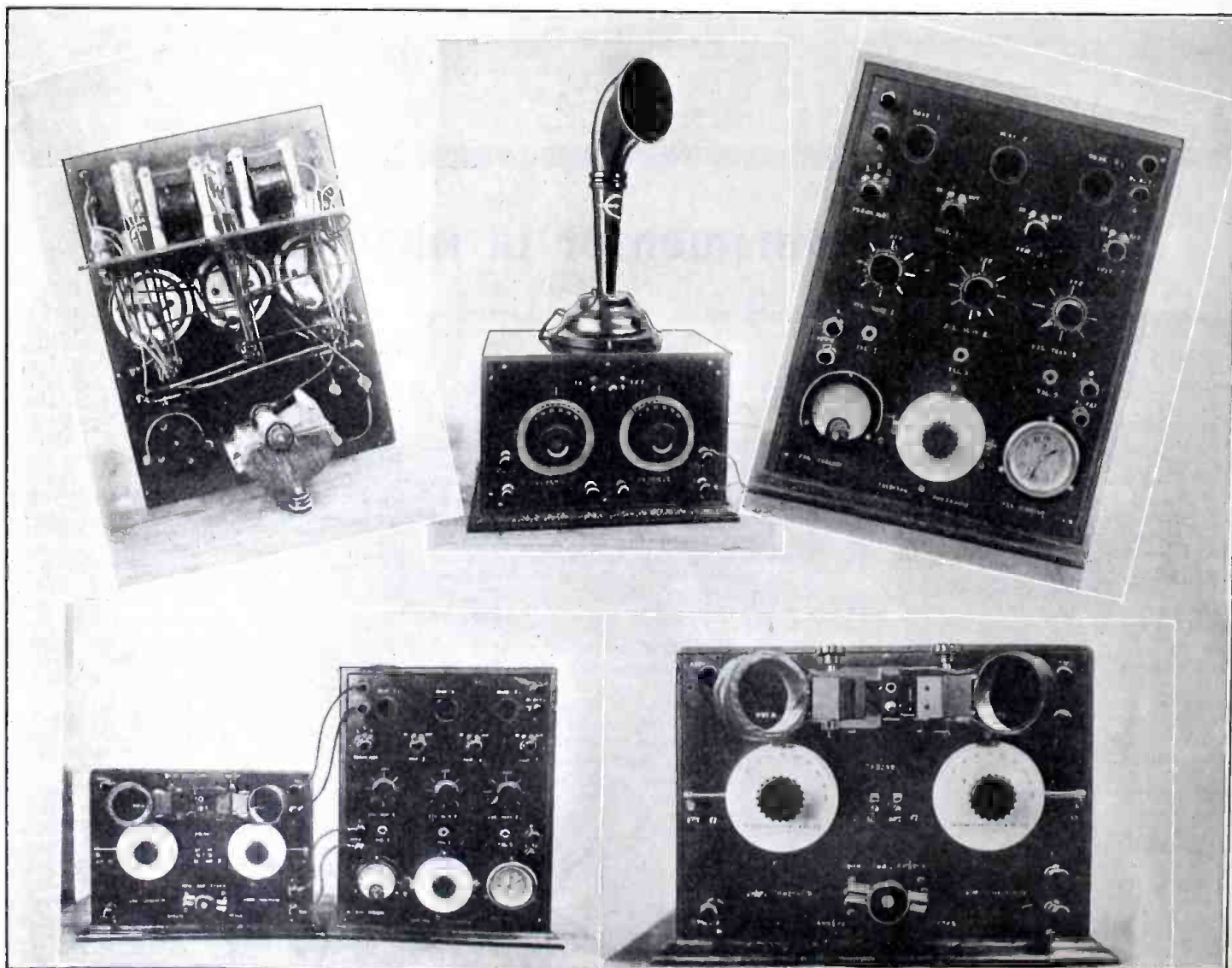

Here is a Star Station Winner of First Prize of Five Dollars. Upper Left Hand Corner Pictures the Wiring and Internal Arrangement. Upper Center—a New Original Loud Speaker. Upper Right—a Front View of Two-Step Amplifier Panel. Note the Well Planned Balancing. Lower Left Shows Receiver and Amplifier Connected for Use. Lower Right—a Very Efficient Form of Honeycomb Inductance Tuner. The General Outlay and Design of All Apparatus Denotes Originality and Efficiency.

aerials were erected at right angles to each other.

Finally the ordered instruments arrived and after a short time the various cabinets were under construction. The final results of my labor are shown in the photographs. The receiving set proper consists of a honeycomb type tuner, having a range from 200 to 25,000 meters, a vacuum tube detector, a two-step amplifier and a loud speaker. For the benefit of other amateurs several details regarding the tuner are given. As shown in the photograph the three coil honeycomb mounting is affixed to the front center of the panel. The panel is of black bakelite. The

primary and secondary variable condensers are of the vernier type and have capacities of .0015 mfd. and .001 mfd., respectively. The grid condenser is the variable type having a capacity of .0005 mfd. A primary switch is provided by which the primary condenser may be connected in either series or parallel or entirely disconnected from the circuit. The circuit used is the tickler feed-back. The cabinet required considerable labor, as they were constructed of veneered panels. In marking the panel standard letter punches were used and the letters filled with white lead.

The cabinet for the two-step amplifier was constructed in the same manner as the tuner cabinet. Mounted close to the panel



Here is Frank Frimmerman on the Job at His Prize-Winning Set. He Seems to Be Ready to Receive Signals From Most Any Place, Including Our Notorious Neighbors Mars and Venus.

in this cabinet is a rack of three vacuum tube sockets, the latter extending thru the panel. Also mounted in the cabinet are two Acme amplifying transformers. Three two-point switches are mounted directly below the sockets on the panel. These are used to turn on the filament currents of the respective tubes. The three-point switch is used to connect a bridging condenser across any one of the bulbs. The ammeter mounted at the left on the panel indicates the filament current of the tubes in use. Three rheostats are provided, one for each tube. The first tube is used as a detector and the remainder for two steps of amplification. The various steps are obtained by plugs and jacks. The flash

twenty-four coils of various sizes are used. These are kept in a rack mounted on the wall when not in use.

With the foregoing equipment I have heard stations in Germany, France, England, Italy, Brazil, etc. Of course, any of the high-powered stations of the United States are easily copied.

At the present time I am interested in wireless telephony and soon hope to complete a radiophone transmitter capable of covering long distances.

Contributed by

FRANK FRIMMERMAN.

334 East 100th Street,  
New York City.

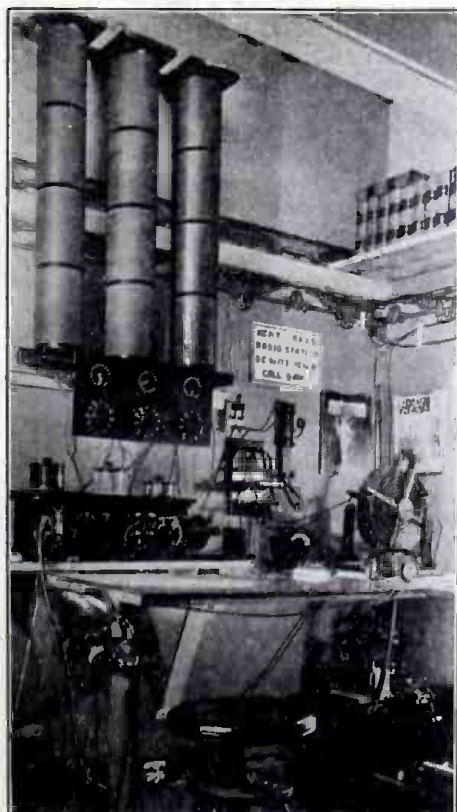

A Radio Station Owned by Kent Bros. Which Will Make Any Amateur Envious.

**KENT BROS. RADIO STATION.**

The photo shows our radio station, 9 G M. For receiving we have a navy type coupler, audion detector, loading coils and condensers. The transmitting set consists of a Thordarson type transformer, sectional Murdock condensers, high speed rotary spark gap and oscillation transformer. With our receiving set we are able to get all the high power stations both ark and spark, also many amateur stations. We are about 150 miles from Chicago and enjoy the concert by wireless telephone from NUR every evening. As yet we have not done a great deal of sending but we get first-class results with our sending outfit.

D. A. KENT,  
De Witt, Iowa.

**JOHN BLAIR'S STATION.**

Here is a picture of my Station to show you amateurs what it looks like.

My sending set consists of a one-half inch spark coil, a spark gap and key. The receiving set is composed of a 2,000 meter loose coupler, a Murdock Loading Inductance, a pair of Holtzer-Cabot 3,000 ohm receivers, a crystal detector, a fixt condenser and to the left you will see a Turney variable air condenser.

Contributed by JOHN BLAIR.  
441 Baldwin Road, South Orange, N. J.

**RUPERT E. KEMPF'S STATION.**

My receiving set has given very gratifying results during the short time it has been

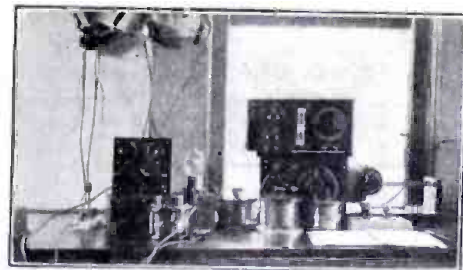

Note the Splendid Arrangement of This Radio Station Owned by John Blair.

operated. Two large receiving transformers and an audion are included in the long wave set while a small transformer is used for short waves. Four variables, a Moorhead V. T., and two pairs of phones and a couple of crystal detectors conclude the set.

I would like to get in touch with any amateurs having high-powered radio sets who live in this section of the country.

Contributed by RUPERT E. KEMPF.

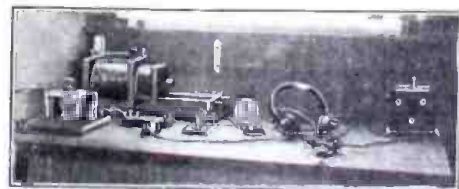

Here is a Neat Receiving Set of Which Rupert E. Kempf is Justly Proud.

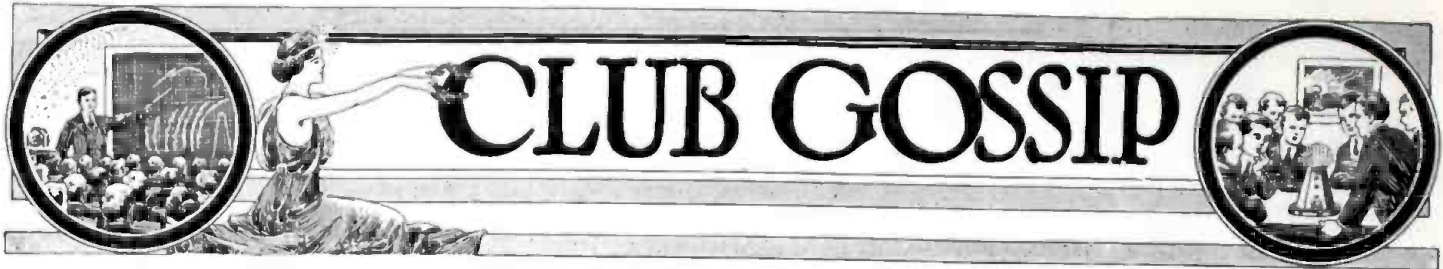

### THE RADIO CLUB OF AMERICA.

The regular monthly meeting of the Radio Club of America was held on Friday evening, January 23, 1920, at Columbia University, New York City. There were fifty members present which was an excellent record of attendance for the first meeting of the year.

An exceedingly interesting paper, "Problems of Vacuum Tube Circuits," was read by L. M. Clement, a well-known radio engineer of the Western Electric Co. Mr. Clement covered in detail a great many of the audion circuits including the detector, amplifier, oscillator, etc. He concluded his discussion with lantern slide illustrations of modern vacuum tube apparatus.

There was considerable excitement and intense interest shown among the members when a tiny three-electrode vacuum tube was exhibited which required so small a filament current that it could easily be operated for fifty hours on one ordinary dry cell.

Prof. Hazeltine, a well-known authority, commended Mr. Clement highly on his extensive work and added several interesting points regarding vacuum tube circuits.

A very interesting talk was given by Mr. Weinberger, of radio fame, upon the modern construction of vacuum tubes.

The results of the election of officers for this year were announced as follows: President E. H. Armstrong; Vice-President, Girard Pacent; Treasurer, E. V. Amy; Corresponding Secretary, T. J. Styles; Recording Secretary, W. S. Lemmon.

The club now has a total of over 130 members

### THE RADIO CLUB OF THE ELIJAH D. CLARK SCHOOL.

1. Our radio club endeavors to give a limited number of our boys a thoro theoretical and practical knowledge of the elementary science and art of wireless telegraphy and telephony.

2. Over a half million radio amateurs are enrolled in the Radio Amateur League of America, and several monthly magazines are solely devoted to this interesting boys' hobby.

3. The club meets once a week after school hours. The work ought not to interfere with the school studies; it will supplement the regular work in elementary science.

4. There is an initiation fee of one dollar and a weekly due of ten cents, all of which is voluntary and is to be spent by the members for their own personal needs in this work.

5. The greater part of the apparatus will be constructed in the woodwork shop; some of it will be bought. All apparatus used in demonstration is the property of the instructor.

6. Parents are invited to encourage any such special inclination on the part of their boys. The field of electrical application is enormous, and for future electrical workers this course will prove helpful.

7. This course will consist of sixty lessons, running through four terms, fifteen lessons of one hour each term. The work will include theoretical and practical work and visits to radio establishments.

8. The work has been outlined with the assistance of Mr. Erwin E. Bucher, chief instruction engineer of the Marconi Wireless Company of America, whose books are to be used as aids in instruction.

9. The lessons have been adapted to the

### ONE CENT A WORD FOR YOU.

*If you have a good true story to tell us about yourself or your station or any unusual radio occurrence or matter connected with radio, we want that story. We will pay one cent a word upon publication for all accepted stories. We desire you to feel that this new magazine is your magazine, and we will do all in our power to make it so. We want to make it as human as it is possible. Will you help?*

needs of our boys by Mr. Robert V. Bucher, late master signal electrician of the United States Army Signal Corps.

10. The actual classwork is in the hands of Dr. Herman V. Bucher, an amateur radio worker for many years and in charge of the department of Manual Training of this school.

The accompanying cut is a fac-simile of a post card sold by the Radio Club of Public School 37, Bronx, N. Y., for the benefit of its radio equipment for one cent each. There is a message on here in the International Wireless Telegraph Code, which you can read very easily if you hold the card at arm's or half arm's length in horizontal position at the level of your eyes. Some can read it more easily with only one eye.

The whole is an optical illusion and it rests on one of the principles of perspective science, that of foreshortening.

GABRIEL R. MASON, Principal.

Here is a Clever Post Card Idea Designed by One of the Club Members. Bring Bottom of Page Close to the Angle of Your Vision and Tip Slightly Up and Down Until the Words of the Message Can Be Read.

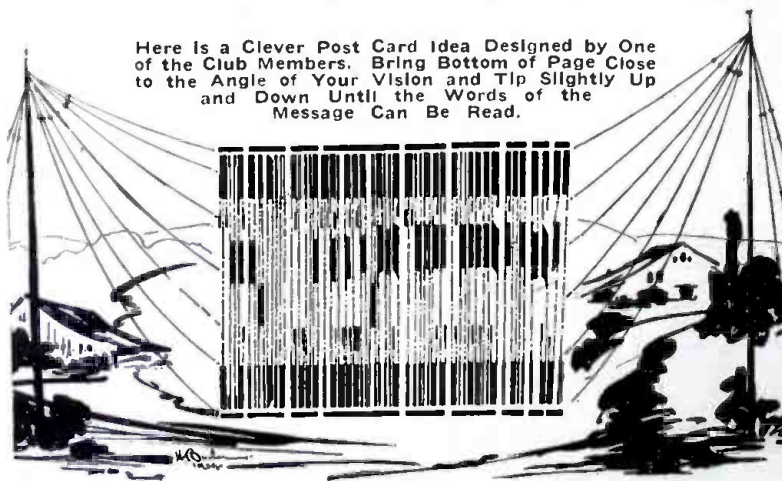

### SOUTH JERSEY RADIO ASSOCIATION.

The South Jersey Radio Association has just elected new officers for the ensuing year. This organization has been in existence for some time. During the war it conducted a radio school and graduated many men who went into the service. It is now looking forward to a bright future and hopes to secure members from all parts of South Jersey. If the fellow "hams" from this part of the country will co-operate with the association we can make it a live, wide-awake one which will benefit everyone.

The meetings are held every third Thursday of the month at Collingswood, N. J.

### THE KISKI RADIO ASSOCIATION.

On January 10, 1920, the first meeting of the Kiski Radio Association, of Salt-drug, Pa., was held. The members are amateurs from all over the country who are attending school at Kiski. After the election of officers a temporary program was adopted as follows: Code practice three nights a week. After the regular business meeting short lectures are given by some of our members who were in service. At present we have a membership of seventeen. We are having a long wave regenerative set made to order and have a small radiophone capable of talking ten miles. At present there is one other station besides the club's at the school. Several of our members are planning to install sets here. Communications via radio (Call 8FQ) and mail are invited.

### LA CROSSE RADIO CLUB.

Dear Sir:

The La Crosse Radio Club, of La Crosse, Wis., is an organization composed of twenty members, ten of whom are student members and the balance regular. We hold regular bimonthly meetings at the local High School Physics Laboratory, and the manner in which these meetings are attended proves the interest its members have in radio work. Three of our regular members have been issued licenses and have been assigned the following calls: E. N. Fridgen, 1615 Avon Street (9CM); F. Frommelt, 1645 Avon Street (9MR); and B. A. Ott, 823 King Street (9HQ). Every member of our club has either applied for a license or is going to as we desire each of our members to be a licensed operator and work a licensed station.

We are proud of our club and believe we have just reasons for this vanity, for to the best of our knowledge we have one of the largest and most active radio clubs in this section of the country. We should be pleased to hear from any other clubs wishing to exchange correspondence and assure them that their letters will receive prompt attention. Address H. Fruith, Sec. and Treas.

**THE SUBURBAN RADIO CLUB.**

A meeting of the Suburban Radio Club of Washington, D. C., was held on January 10th, and the following officers were elected for the coming year:

President, John V. Pursell, 215 Wootton Ave., Chevy Chase Station, D. C.; chief operator, Francis Baer, 1744 Corcoran St., N. W.; secretary-treasurer, Charles R. Seckinger, 755 Quebec St., N. W.

The Suburban Radio Club, or "S. R. C.," as it is known locally, was organized in the fall of 1912 and enjoyed a continuous and active existence from that time until the outbreak of the war. At first most of the members were to be found in the north-west suburbs of the city, and much successful communication between country points was maintained. Later, however, many members having stations in the city were added to the club's roll, so that the organization became fairly representative of this locality.

Membership in the S. R. C. has been of the greatest benefit to all those who have availed themselves of its privileges, among which are the use of the club's various instruments, such as wavemeter, ammeters, etc., the interchange of ideas, aid in the erection of antennae, and last but not least, agreeable, social meetings at the homes of members. The dues have always been kept so low that membership in the club is within the means of the poorest amateur. Candidates undergo a strict investigation, however, before being admitted to membership.

In the war the S. R. C. furnished the following assistance to the Government: Naval operators, 8; Army, Signal Corps, 1; Marine Corps, 1; Officers' Training Corps, 1; radio instructors, 6. How about this record if you doubt the value of amateur radio?

The Suburban Radio Club is also proud of having taken an active part in the defeat of the pernicious radio bill introduced by the Navy Department after the close of the war.

In conclusion it may be said that our members are taking up radio with even more enthusiasm than displayed before the war, and as soon as proper aerials can be erected and amplifiers put in working order some wonderful achievements are confidently anticipated.

**THE YATES RADIO CLUB.**

The Yates Radio Club held its first meeting on Wednesday evening, January 7th, at 7:15 P. M.

The following are the officers which were elected, also the by-laws adopted:

President, William C. Babcock; vice-president, Frederick O. Lee; secretary-treasurer, Robert M. Edmonds.

**BY-LAWS:**

1. The club shall be called the "Yates Radio Club."
2. The purpose of the club shall be to discuss wireless telegraphy and all branches of the electrical field.
3. The members shall be expected to abide by the laws.
4. That five members shall form a quorum.
5. The officers shall be elected for a period of four months and are subject to re-election.
6. Dues shall be \$4 per year, payable quarterly and ten cents at each meeting.
7. The money shall be deposited in the bank to the credit of the Yates Radio Club.
8. The meetings shall be held on Wednesday of each week at 7:15 P. M. at 112 Head St., Penn Yan, N. Y., unless otherwise voted.
9. Money is to be spent only by vote of the club.
10. One half hour shall be spent at each meeting for code practice. The president shall appoint a speaker for each meeting.

11. By-laws are subject to amendment only by majority vote of all members.

The club will be glad to communicate with any amateurs or clubs. It is hoped to install a 1 K.W. transmitter in a few weeks. A receiving set is now available, which is capable of receiving amateur stations in Indiana and European stations, such as Rome, Lyons, Nauen, Hanover and the Pacific Coast.

All communications will please be sent to the president.

**CANTON RADIO CLUB.**

Members of the Canton Radio Club, which was organized last October at the McKinley high school of Canton, Ohio, have been doing some exceptional work in assisting with relay messages and in receiving messages from distant stations. Messages have been heard by several members of the club who have high power stations, from Nauen, Germany, Carnovan, Wales and from Norway.

Wilson Weckel, president of the club, who has one of the most complete stations in the city at his home, has heard messages from the new Norway station.

Lewis Ripple has heard messages from Germany and from Wales.

Recently Weckel received a message from a school mate, "Bill" Van Schoyck,

**Radio Articles in  
February Issue  
Electrical Experimenter**

*Audions Stronger Than Sun.*

*Vacuum Tube Circuits—by Pierre H. Boucheron, U. S. N. R. F.*

*Radio Telephony and the Airplane—by Wm. C. Mundt.*

*Making a Wavemeter Direct Reading—by Wendell King.*

*A Small Radio Frequency Alternator—by R. H. Owen.*

*An Improved Loose Coupler—by Frank H. Broome, B.Sc.*

*Getting Together on the Antenna—by E. T. Jones.*

who attended Dodge Radio Institute at Valparaiso, Ind. The message came thru from Gibson City, Ill., in 29 hours after it was sent. In the message Weckel's school mate inquired as to his health, and commented on various subjects.

Weckel also received a letter from a man who has a station in Peoria, Ill., 430 miles distance, in which he stated that he had heard Weckel's messages.

Elmer Volzer, another member of the club, heard a message from Poughkeepsie, N. Y., a distance of 400 miles, while at his station Wednesday night.

**THE RADIO CLUB OF SYRACUSE.**

Five young radio enthusiasts—Dr. Richard H. Hutchings, Jr., Neil W. Flaherty, Donald C. Wood, Charles A. Hagaman and Clem C. Bean, of Syracuse, N. Y., have organized "The Radio Club of Syracuse" and elected the following officers: Dr. Hutchings, president; C. C. Bean, vice-president; D. C. Wood, secretary and treasurer, and N. W. Flaherty, instructor.

Dr. Hutchings, president and senior member of the new organization, had been considering a movement for some time and the need was emphasized recently when a radiogram from St. Louis had to be sent here from Utica by mail. He communicated with several others whom he knew would be interested in a project of this kind, and arranged for the meeting

which resulted in the formation of the organization.

The five members have had considerable experience in receiving and sending wireless messages, as each had an apparatus in his home before the war. Mr. Flaherty, instructor of the club, has had a wide experience in wireless, having been connected with a railroad company as telegrapher before the war, in which he served as a radio operator in the navy. Mr. Flaherty and Mr. Bean now have a "wireless" in the home of the latter.

It is the intention of the club to open rooms soon on the top floor of some high building, where they can install a first class receiving and sending apparatus, and with the aid of a two-step amplifier, they hope to be able to receive messages from England, the Eiffel Tower in France and Nauen, Germany. The clubrooms are to be open at all hours for the use of the members for study and for practice at the instrument to perfect them in the art of receiving messages at a good rate of speed. Classes are held on Friday night of each week under the instruction of Mr. Flaherty, and papers on interesting radio phases will be read every month.

The club is open for membership to all young men, regardless of experience, who are interested in radio work, as it is the purpose of the organization to stimulate local interest in wireless telegraphy.

**ORANGE MOUNTAIN RADIO CLUB.**

This club was organized for the promotion of amateurs who are still in the first stages. This club has fifteen members so far and hopes to secure many more. The club is a subscriber to all scientific magazines, and work on wireless. Each member must be between the ages of 14 and 21 and must pay dues of \$3 a year for the upkeep of the club. He must be thoroughly acquainted with the Morse and Continental and must be able to handle his instruments with proper judgment. Anyone desiring to join must send 50 cents for enrollment blank and button.

He must have a receiving set capable of receiving at least a thousand miles. After he has enrolled and paid all fees he will be accepted as an honorary member, and every day, excepting Sundays, a call will be sent out in secret code to all members by wireless telephone, if he should live in commuting distance and desires to come to the regular meetings. He may write stating when he will call, and arrangements will be made for him.

We send bulletins every month to all members listing the new codes and new members admitted, also happenings in the club.

Those desiring to correspond will please address Pierce MacFadden, Box 55, South Orange, N. J., Secretary.

**GENOA, ILL., AMATEURS WANT RADIO CLUB.**

Several amateurs in the vicinity of Genoa, Illinois, desire to organize a Radio Club. The purpose of the club is to promote interest in all branches of radio, such as code work, technical studies, construction and design of apparatus, etc.

In order to become charter members the following requirements are necessary: Each applicant must be able to send and receive not less than five words per minute. All members who are proficient in sending and receiving around twenty words per minute will be called upon to instruct the beginners.

The construction of an elaborate receiving station has been planned for the headquarters station. Also arrangements will be made to install a 1 K.W. quenched spark transmitter.

All communications should be addressed to Earle L. Russell, Lock Box 256, Genoa, Illinois. (Continued on page 448)



# The RADIO LEAGUE of AMERICA

HONORARY MEMBERS  
ADMIRAL W.H.G. BULLARD, U.S.N. NIKOLA TESLA  
PROF. REGINALD FESSENDEN DR. LEE DE FOREST  
Manager, H. Gernsback



## The Amateur's Position

By H. GERNSBACK

**T**HE Radio League of America was born in October, 1915. It succeeded the Wireless Association of America founded by the writer in 1909.

It is well known that the Radio League of America is the largest radio organization in the world, numbering today (February 1, 1920), 22,691 members, all active amateurs.

For those who do not know much about the League the following extract from the Certificate of Incorporation of the League will prove more illuminating than a lengthy statement:

### THE PURPOSES OF THE LEAGUE.

The purposes of the R. L. O. A. are as follows:

"To promote the art of amateur wireless telegraphy and telephony in the United States among the members of the said League; to have available for the Government of the United States or any of its officials a complete list of all the amateur radio stations in the country pledged to the service of the Government for use in times of national danger or need; to establish a uniformity in the transmission of wireless messages by amateurs; to uphold the provisions of a law known as the Wireless Act of 1912 and all subsequent laws pertaining to wireless telegraphy; to assist the Government of the United States or any of its officials in apprehending offenders thereof; to prevent the sending of misleading wireless messages; to give information to the members of the said corporation concerning new and useful devices in the operation of wireless telegraphy and telephony and to provide an organization for the interchange of ideas concerning wireless telegraphy and telephony for the benefit of the members and the public at large."

It should be borne in mind that the R. L. O. A. is a purely scientific body of national scope. NOT A MONEYMAKING ORGANIZATION, as for instance several other now existing organizations in this country, which charge dues, fees, as well as enrollment fees.

The R. L. O. A. exacts no dues, no fees, no charges

whatsoever. Any American radio amateur in good standing may join the League upon signing of the application blank, printed at the end of this article.

As soon as the New York headquarters have received the application, the applicant will receive free of charge the engraved certificate of membership reproduced, great-

as it concerns the American amateur.

The membership is for life as long as the member remains in good standing. Should the Board receive authentic information that a member has used his radio set for unlawful purposes, or wilfully persists in interfering with Government or commercial stations, such a member on vote of the Board will be expelled from the League. It is with pride that the writer reports that during the four and one-half years of the League's existence, *not a single member has been expelled.* To be sure many complaints reached headquarters, but as a rule a single warning from the board was sufficient to bring the erring member to his senses.

### NAVY DEPARTMENT The SECRETARY OF THE NAVY.

Washington,  
Sept. 27, 1917.

"The work you are doing in connection with the 'Radio Roll of Honor' (Radio League of America) and the past work you have accomplished in furnishing this Department with the names of many amateurs thruout the country, is very much appreciated, and I am sure much good will come from your patriotic endeavors."

Yours respectfully,  
(Signed) JOSEPHUS DANIELS

Mr. H. Gernsback,  
Manager Radio League of America,  
New York City

ly reduced on this page. This beautiful certificate measures 15" x 12" and is printed in green, gold and black. The official League's gold seal is embossed in the lower left-hand corner. The front of the certificate contains all the rules of the League, while on the back there is reproduced the full text of the Radio Act of 1912, as far

### PRIDE OF MEMBERS.

That the members of the R. L. O. A. take great pride in belonging to this, the greatest Radio Association, is readily shown, when one visits amateur stations thruout the country. The certificate of membership is invariably displayed in the amateur's den, and it is rare indeed that a first class station is found without it. That the members think highly of their certificate is readily seen by the fact that nine-tenths of them are framed in expensive frames costing from \$2.00 upwards. The writer even saw a gold frame in Cleveland recently, which, so the owner assured us, cost \$10.00. But this probably is the limit as well as exceptional. Members, too, take great pride in their certificate, because it lends "tone" to their station. The stranger or visitor strolling into the station is invariably impressed with the document,

and even the visiting Government Radio Inspector makes a mental note of it. He knows the member must be in good standing. He also knows that the possessor would not have the certificate unless he had FIRST pledged his word in writing that he was going to abide by the rules of the game. And that pledge, he knows too, is safely locked away in Washington.

### HOW IT WORKS.

As mentioned before, every applicant to be eligible as a member in the R. L. O. A. must first sign a blank pledging himself to abide by all the rules of the League as well as the Radio Act of 1912.

When the blank is received in New York, a copy is

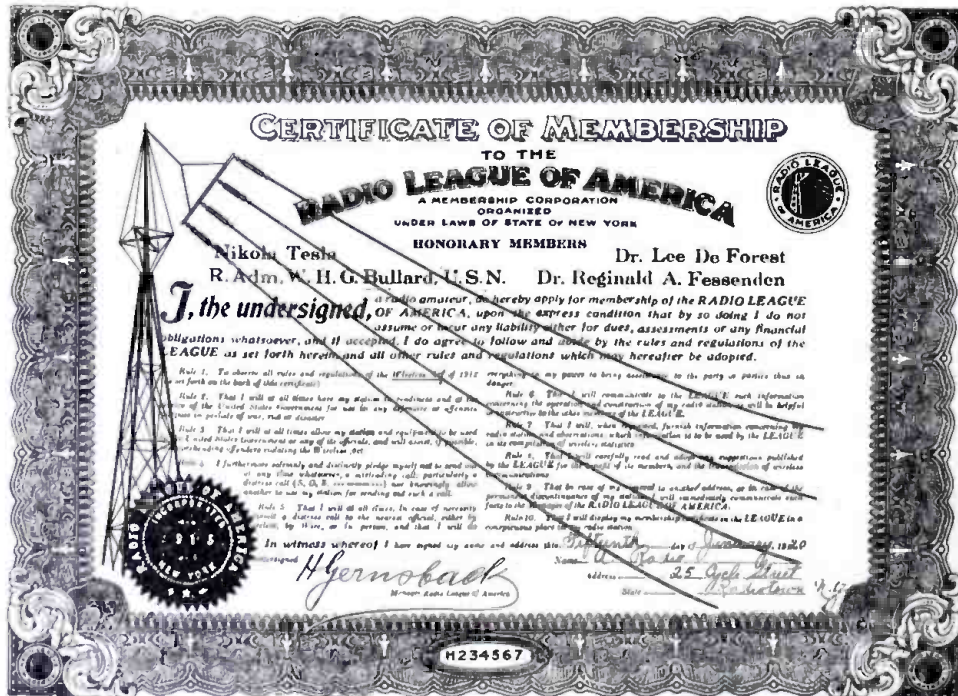

This is a Reproduction (Greatly Reduced) of the League's Membership Certificate. The Original is Printed in Gold, Green and Black. The Full Size is 15" x 12". It is Given Free to Every Member.



made for the records on an index card which later is filed alphabetically by States in the League's steel files.

The original, however, is sent to the authorities in Washington. Now let us see what happens. In 1917 when the United States entered the war there was a great dearth of radio operators. The demand could not be possibly satisfied thru the ordinary channels. And here is where the League went to war with flying banners.

The Navy Department (and later the Army) had of course a record of the League's members and immediately set its machinery working to enlist these radio amateur members. Thousands of members were thus procured *due directly* thru the organization of the League, which had foreseen just such an emergency, and for two years had not ceased in enrolling members. It was indeed fortunate that the League had as its official organ the *Electrical Experimenter*, and due to the large circulation of this magazine practically every amateur in America became familiar with the League.

How important the work was that the League did during the war is best shown by the many letters and telegrams from the Government, from different states thruout the country beseeching the League for the names of radio members.

To mention but a few. Secretary Daniels of the United States Navy was much pleased with the services of the League. His letter is reproduced here.

Capt. (now Admiral) W. H. Bullard, of the U. S. Naval Radio Service, Navy Department, wrote (excerpted):

"You can readily understand that any information collected by the Radio League will be of the greatest value to this service and this office will be glad to avail itself of your kind offer to furnish such free of all cost. This to contain the names, location, etc., of all amateurs in the United States."

Many similar letters and messages reached us during the war. Lack of space does not permit to reprint all of them in this issue.

**THE LEAGUE'S BIG STICK.**

But the real test of the League came just a little over a year ago. The Government had as yet not lifted the ban on radio, and the amateurs were still dreaming of the "days before the war." Dreaming as a matter of fact was all they were permitted to do during those days. Then suddenly without warning some one in Washington conceived the splendid idea that as long as the amateurs were hibernating, well, then, this was the chance of a lifetime to suffocate them; nay, wipe them off the map. The now famous, or shall we say infamous, Alexander Bill, H. R. 13159, was scheduled to pussyfoot its way thru Con-

**MONTHLY PRIZES**

- A First Prize of \$10.00
- A Second " " 5.00
- A Third " " 3.00

will be paid hereafter every month for the best three letters published on this page, by members of the R. L. O. A.

The subject of the letters is "WHAT THE R. L. O. A. HAS DONE FOR ME"

Directly due to the League thousands of amateur members enlisted in either Army or Navy. Every member must have some good story to tell us. We want that story for the benefit of other members. If you did not enlist, but wish to write on another topic AS LONG AS IT HAS A CONNECTION WITH THE R. L. O. A. YOU MAY DO SO. Such a letter may win the 1st prize as well.

If only one letter is printed, that letter will be paid for at the rate of \$10.

Address all letters:

PRIZE CONTEST,  
RADIO LEAGUE OF AMERICA  
231 Fulton St. New York City

gress with a speed approaching that of light, or as some one put it, with the "speed of greased radio waves."

But they had not counted upon the Radio League of America. Without hesitation New York headquarters at great expense sent out, almost overnight, over 20,000 letters to all the members, giving the facts of the case, as well as a reprint of the bill. (Besides some 30,000 were sent to other amateurs who were not members. There were but 20,000 members at that time.) The effect was instantaneous. Washington was deluged with letters and telegrams. Every Congressman, every Senator received dozens of them. These letters and telegrams were seriously worded and proved of tremendous moral value. They

showed, too, the solidarity of the amateurs as a great body, and naturally Washington sat up and took notice with a big N.

The bill in due course was killed. The amateurs had won their battle. Now please note particularly that *no other radio organization made any such organized massed effort* to defeat the dangerous bill. Only one concern, a large New York electrical supply house, sent out letters to amateurs appraising them of the impending danger. The other radio organizations did practically nothing of import. It is true that they sent a few men to Washington, *after* the hearings had already started, but they accomplish nothing, because the R. L. O. A. had already won the battle long before these gentlemen reached Washington.

**NEW RADIO BILLS COMING.**

It will come as a surprise to many that more radio bills are coming up for discussion in Congress this spring or early summer. You will note that this is the first notice in print to that effect. The Radio League of America as a rule gets the information first. In due time the bills will be printed here as soon as they are published. The writer understands that these bills are drastic and similar to the 1918 crop. However, with the help of the League we need not despair. All we want now is members and still more members, so we can go into the battle strong and well fortified in case radio amateurism is threatened once more.

In our next issue we will speak about the benefits of the R. L. O. A. as far as radio clubs and associations are concerned.

In the meanwhile, if you are not a member, don't fail to sign the application blank. If you are a member, it is your sacred duty to find at least one new member. We shall soon need them all. So please don't delay.

**Application for Membership in the Radio League of America**

I, THE UNDERSIGNED, a Radio Amateur, am the owner of a Wireless Station described in full on a separate sheet attached hereto. My station has been in use since....., and I herewith desire to apply for membership in the RADIO LEAGUE OF AMERICA. I have read all the rules of the LEAGUE, and I hereby pledge my word to abide by all the rules, and I particularly pledge my station to the United States Government in the event of war, if such occasion should arise.

I understand that this blank with my signature will be sent to the United States Government officials at Washington, who will make a record of my station.

Witnesses to signature: \_\_\_\_\_ Name .....

..... City .....

..... State .....

..... Date ..... 191

In the event of national peril, will you volunteer your services as a radio operator in the interest of the U. S. Government?.....

**NOTE:—**This last question need not be answered unless you so desire it. The rules of the League are printed on the Membership Certificate published on the first page of this article.

Send this blank to Radio League of America, 231 Fulton St., N. Y. C.

**A Curbstone Antenna**

By Stanley E. Hyde

WITH the recent advent of the "Ground Antenna" it is hoped that the following information will be of use to those radio experimenters who are experimenting with "Underground" radio, and more particularly to those who have a limited amount of real estate upon which to carry out their plans and experiments.

The results below were obtained by using an ordinary galena detector and loosely coupled receiver, no audions being employed, altho undoubtedly the use of a good audion receiver would have greatly increased the intensity of received signals.



An Aerial Using the Curbstone as a Support.

In front of the writer's residence is a wooden curb "stone" about 10 inches high, the house being approximately in the center of a 600-foot block.

About 600 feet of No. 10 weather-proof copper wire was tacked along the wooden curbing from one corner of the street to the next corner. Where there were inclined driveways from other residences the wire was led down the curbing and laid on the pavement as shown in Fig. 1. A lead-in was taken from the wire in front of the house and led thru a drainpipe under the sidewalk, the drainpipe's function being that of carrying drainwater from the eaves

(Continued on page 451)



# Junior Radio Course

**I**N our last lesson we have taken into consideration the two main wave forms, namely damped and undamped. We have discussed the meanings of wave damping and how waves differ. We will now look into the "sub-heads" of the damped wave forms, namely those which are generated in the ordinary spark and condenser discharges.

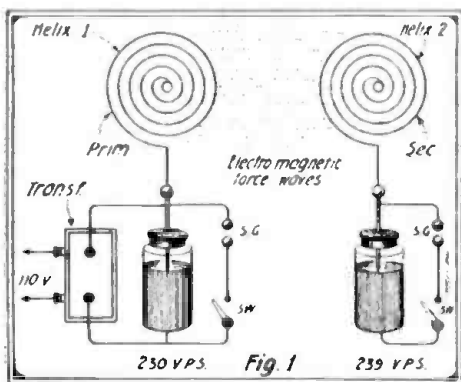

Showing How Waves Are Transmitted from One Oscillating Circuit to Another.

There are, roughly speaking, three classes of waves which come under this heading:

1. A broad wave.
2. A hump wave.
3. A sharp wave.

The latter is most desired and in fact required by the government authorities, if you own a transmitting set. Let us now see what happens in a circuit emitting a sharp wave, for instance an oscillation transformer or two helices (see illustration Fig. 1) will answer the purpose of explaining this. Let us call the original power (driving end) the *primary circuit* and the one which is near it and influenced by it, the *secondary circuit*. If the primary circuit is now closed thru a transformer, spark gap, Leyden jar (a form condenser) and switch, the primary will oscillate at a frequency of its own.

Supposing now that we close the switch of the secondary helix, located a foot away from the primary. There will be immedi-

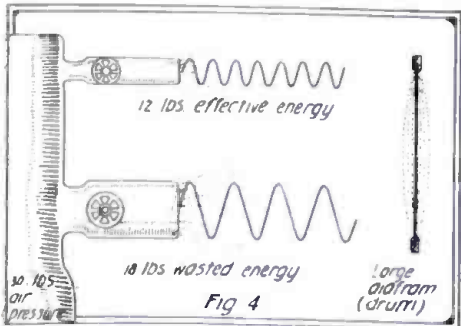

Illustrating the Production of "Beats" With Two Organ Pipes Differing Slightly in Pitch.

ately impress upon it some of the electro-motive force sent from the primary circuit. This will make the secondary oscillate, but at a frequency of its own. A spark will now jump across the little gap and cause this circuit to oscillate in turn at a frequency of its own. But this game works just as well two ways, and the force induced in Helix No. 2 will again send over a similar forced oscillation over to the primary Helix and circuit No. 1. In other words, we have here an *electrical echo*. In this way it influences the original primary oscillations.

It will readily be seen that a very complex series of waves is set up, due to the fact that one kind of vibration is free, and the other is being forced upon it by a circuit (either primary or secondary). If both pieces of apparatus are shifted closer together, this effect is even more pronounced, inasmuch as a series of sparks will take place in both circuits between the gaps, when only circuit No. 1 had a current supply. (Note that Helix No. 2 has no transformer.) Assuming, therefore, that the frequencies of vibration are different in each circuit 1 and 2, we naturally would wonder what the resulting wave would be.

Well, let us see!

Take a telephone receiver and a telephone transmitter, Fig. 2, connect them in series with a battery and place them close together. If the transmitter is disturbed slightly, several sounds will be emitted. One

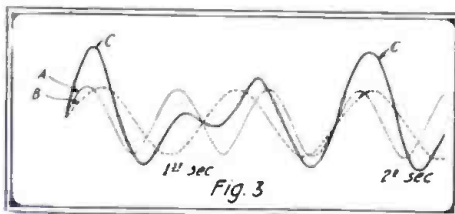

Here is Shown the Natural Transmitter Wave, the Natural Receiver Wave (B) and the Resulting Wave (C).

of these sounds is due directly to the vibration of the diaphragm of the telephone receiver. The other is due to the diaphragm of the transmitter. It will then be seen that when the receiver, inasmuch as it is placed close to the transmitter, sets forth a sound, this sound makes the transmitter diaphragm send out a current impulse which is again transferred to the receiver. An echo, in other words. In this way we have the definite sound of the receiver diaphragm itself, the definite sound of the transmitter diaphragm itself, and the resulting sound called "howling" due to both of them.

In Fig. 2 let us say that the diaphragm of the receiver vibrates four times per second and that of the transmitter five times in the same interval. Of course, there must be a resultant; that is to say, a sound wave will result that will be different than the waves of either the natural 4 vibrations and 5 vibrations. These waves are caused

by a bucking action of one side upon the other being in reality a combination of the two. We have, therefore, in Fig. 3 the natural transmitter wave, in the same figure B, the natural receiver wave, and in C the resulting wave from the combined wave forms of the two.

You will note the wave at its highest point of undulation or wave motion is

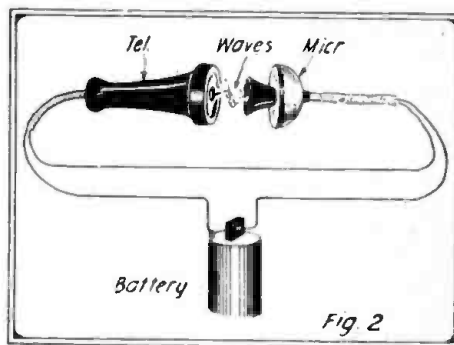

The Howler Circuit Used as an Analogy of an Oscillating Circuit.

higher than the free or natural wave. This results in the formation of what is termed "beats" in radio circuits. Suppose that the wave of the transmitter diaphragm would vibrate freely twenty-four times per second and the one of the receiver diaphragm would vibrate freely thirty times per second, provided there was nothing to hinder it. This makes a difference of six (subtracting one from the other) which will be the number of "beats" produced every second.

Another very simple analogy would be to listen to two organ pipes (Fig. 4) whose difference in pitch is very slight. A peculiar sound would be heard, which gets louder and softer a certain number of times every second. This is termed "beating" and has an important use in radio later described.

These analogies are very similar to the electrical beat formation we use in radio. Two waves, one from the primary circuit and one from the secondary circuit, are set up and their resultant causes beats. A transfer of the energy from one instrument to the other (in the telephone analogy) is just as undesirable as is a transfer of energy from the radio primary to the secondary circuit, and back again.

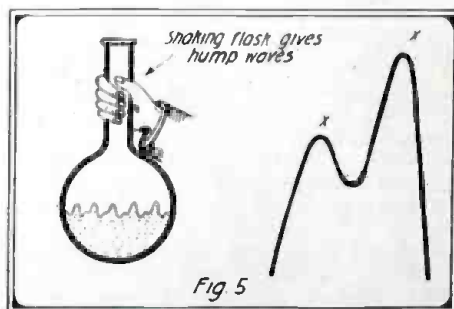

Obtaining an Analogy of the Hump Wave as Shown by Shaking the Flask.

Each time such transfer is made, a lot of the energy is lost, in heat in the case of radio and in friction, heat and magnetic losses, in the case of the phone.

In addition, the transfer of the energy from one to the other is also undesirable because it sends out not only the waves of its own vibrating period, but also the wave of the resulting vibration period of the two circuits. Hence, a receiving station

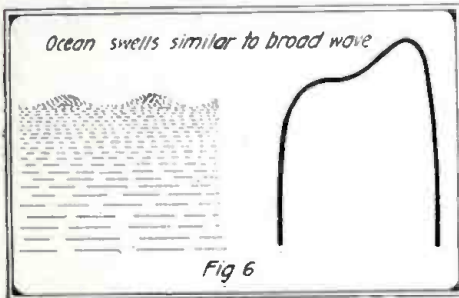

A Broad Wave Is Similar to the Large Ocean Swells.

or (in the case of the organ pipes) a device which will receive a selected sound can be tuned to hear either one or the other, but not both at the same time. So, we perceive, that the force necessary to make the organ pipes sound or the force necessary to send out an ether wave, is half wasted by producing a sound which cannot be heard. Likewise the other sound may interfere with a station operating on a wavelength similar to it. Hence, it is absolutely necessary that we transmit but one sound from a station. This is readily done by several means in radio,—all of which attempt to send out a pure sharp wave.

We have just now spoken of a pure sharp wave. Now let us attempt to see what this is. Suppose we have some method as has just been stated, of obtaining two frequencies, but very slightly different. Both these frequencies may join, so as to form a wave with a hump (Fig. 5). But if we now change the coupling (coupling means changing the distance, i. e., separating the

**A NOVEL CONDENSER.**

Secure an old electric light and mix a pan of good strong salt solution. Next dip the globe into this solution and with a pair of small pliers remove the tip of the globe. The water will rush into the inside of the globe. Next seal with paraffin.

Cover the outside of the globe with tin foil as shown in the drawing. A number of these condensers may be connected together. I am using one of these condensers for experimenting and it works very well.—Contributed by HARVEY SCHROEDER.

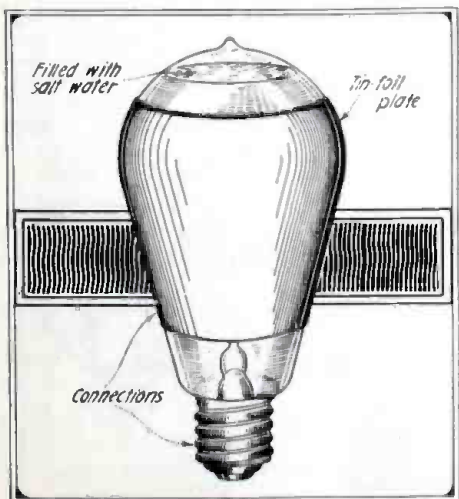

An Electric Light Globe Filled With Salt Water and Having an External Plate of Tin-foil Forms a Simple Condenser.

primary helix and the secondary helix), both these wave forms tend to merge into one, giving as a result, a very broad wave. Fig. 6.

If we take a beaker of water and agitate it excessively, we will get two wave motion forms from one larger than the other and both joining each other: A typical hump wave. If we now take a view of the ocean on a calm day and see the beautiful swells, we get a broad wave. As for sharp waves, a sharp choppy day will illustrate this form and all of us have seen it at some time or other when on the beach during a storm.

To produce this effect in radio we increase the distance between the primary helix and the secondary helix still more and we find that we obtain a wave which goes up to a peak directly and quickly and all the energy forms only one "tune." This is exactly what happens and the reason for it is that the primary does not "echo back" the energy from the secondary and form the jumble of waves heretofore described. Such action is likewise made possible by the quenched spark gap.

What is a quenched spark gap? Essentially it consists of a large number of discs having a grooved surface in the center. They are separated from each other only by a slight thickness of some insulating material. In this way the spark gap proper is divided up into a series of short gaps each presenting a very large sparking surface and at the same time allowing for cooling.

The purpose of its use is to induce the secondary circuit to be given a sudden blow and then allow it to continue to vibrate at its own period just like a bell being struck a sharp blow with a hammer.

If a gap of this nature is inserted into the primary circuit it prevents re-establishment of a spark discharge after the first primary undulations have ceased, allowing the secondary to vibrate at its own period.

This is exactly the same as the following simple phenomenon: We take a bell and strike it smartly with a hammer. Both the hammer and the bell will vibrate, due to the impact of the two and the molecular

disturbance set up. However, the vibrations of the hammer are scarcely heard, as they die down very rapidly, but the bell continues to vibrate, giving us a clear metallic note sound.

If we took two bells, covering one with a heavy layer of felt and struck both of them together, only one bell would vibrate sufficiently to be heard, the felt being the quenched gap preventing the oscillation of

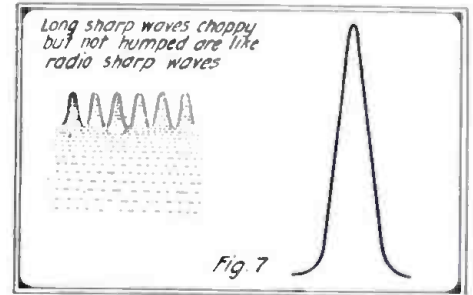

The Sharp Wave Shown Here is the Essential Wave in Radio.

one bell from making itself heard, and allowing the other bell to oscillate freely at its own period of vibration. In the case of radio, the quenched gap allows the secondary to vibrate freely at its own period of vibration and at the same time quenches the action in the primary circuit.

**QUESTIONS FOR THIS LESSON.**

- What are subdivisions of wave forms of the damped kind?
- What is a sharp wave?
- What is a broad wave?
- What is a humped wave?
- Why are two waves or tunes formed in a circuit?
- What advantage or disadvantage is a two-wave transmitter?
- Give an analogy of formation of waves of different frequency?
- Illustrate formation of beats.
- Give analogy of the effect of an oscillation transformer.
- What is a quenched gap?
- What advantage has it over another gap?

**GRAPHITE RESISTANCE UNIT.**

Amateurs are often in need of resistance

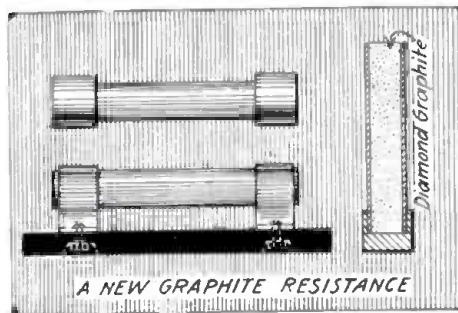

units for various circuits, such as the "A" Battery circuit of an Audion, or the field circuit of a rotary spark-gap motor, etc. A unit which has been found successful for such work may be made from an old blown out 25 ampere fuse, filled with diamond graphite as shown in the drawing.

[By packing the graphite more or less, a considerable variation in resistance is had.—Editor]

Contributed by DON C. BROCKWAY.

**AN AMATEUR LOUD SPEAKER.**

Here is a stunt for you fellows who have had the sad experience of not having enough phones to go 'round when "the old man" invites his friends up to hear the Navy Yard trying to see how broad a wave they can use. Take a cardboard tube about 2 3/4" in diameter and not more than five inches long. The diameter of the tube depends upon the size of the phones. I used a pair of Murdock 55's, so the tube

used was 2 1/16" in diameter. Now put one phone in each end with the diaphragms pointing in. Secure a megaphone or make one of cardboard and cut a hole in one side of the cardboard tube just large enough for the small end of the megaphone to fit into. Fasten the megaphone to the tube and turn on the twelve-step amplifier and hold your ears. With this stunt all the faint stations heard in phones not only can be heard in the loud talker but are amplified. The megaphone may be fastened into the cardboard tube by a little sealing wax.

Contributed by W. W. BRINCKERHOFF.

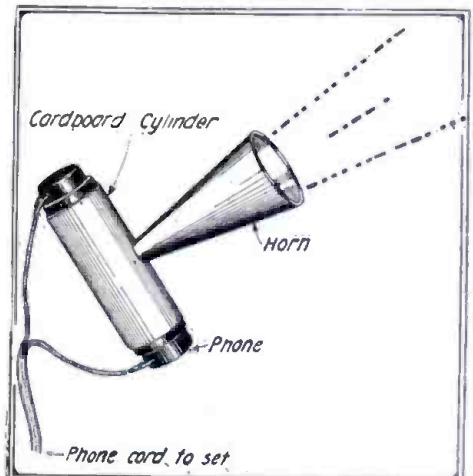

A Receiver Placed In Each End of a Tube, as Shown, Gives Excellent Results as a Loud Speaker.

# Junior Constructor

## DETECTOR WITH UNIT CRYSTALS.

The accompanying drawing shows a

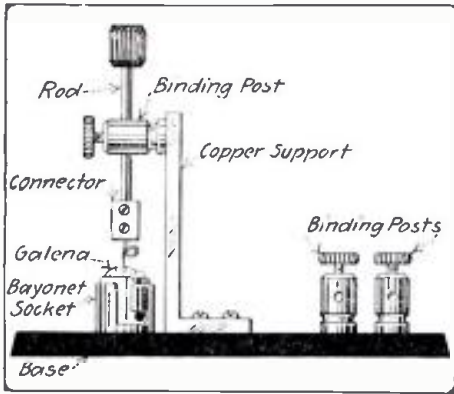

Here is a Novel Form of Detector Stand in Which the Unit Crystals May Be Used.

cheap but very efficient detector made from material which can be found in any camp of a "radio bug."

First secure a base which can be either rubber, fibre or shellacked wood; then get a heavy copper strip about three inches long and punch or drill a hole at each end, bend one end at right angles and run a wood screw through the hole, fastening it securely to the base. Take a binding post and fasten it at the other end of the copper strip; next get a small brass rod which is threaded on one end and put it through the hole in the binding post. Twist a hard rubber knob on the threaded end, and on the other end put a wire connector so as to connect the brass rod with the cat whisker; the cat whisker can be soldered to the end of the rod if preferred. For the mineral cup take a bayonet socket and sink it into the base until the end of the socket is even with the bottom of the base. Now procure an old auto lamp and break off all the glass, leaving the insulating compound at the bottom; mount a piece of galena in the auto lamp base with Wood's metal; now place this auto lamp base or mineral cup in the socket. Make connections to the binding posts and the detector is ready for use. Many of these mineral cups can be made for using different minerals, and it takes but a second to change from one cup to another.

Contributed by

EDWARD L. FRIEDMAN.

## AERIAL SWITCH.

A double pole, double throw snap-switch, connected as shown, will save the expense of a regular aerial switch, when only a receiving set is used.

When the blades are in position 1 (as shown in the diagram) the aerial is grounded and the primary of the receiving set is short circuited. To receive, turn the blades to position 2.

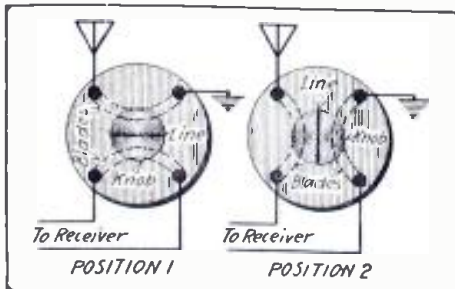

A Snap Switch Connected as Shown Will Serve as an Excellent Antenna Switch.

These positions are indicated by a line drawn across the top of the switch knob with the point of a hot soldering iron.

Contributed by

ROBERT HERTZBERG.

## A SEALED CRYSTAL DETECTOR.

This type of crystal detector is very valuable in small portable sets, where the buzzer test for every signal is too much bother. The detector is always ready for use and requires no adjustment. It can be made in half an hour and will prove a very satisfactory instrument.

Description: B is a small wood box which had contained some Radiocite mineral. C is a small brass cup which is fastened to the box by means of a machine screw passing thru the bottom of the box. E is a machine screw which holds the crystal D in place; F is a contact point which is used as a post. G, the catwhisker, and H, a wire, are both soldered to F. H runs to a binding post A. J is a wire soldered to the cup C and runs to a binding post A.

The next step is to fasten the catwhisker to the crystal.

Connect the detector as for a buzzer test. When the most sensitive spot is found, heat some sealing wax and drop some of it on the crystal, thus holding the catwhisker in place. Always keep the buzzer running for by so doing you can easily tell if the sealing wax knocks the detector out of adjustment.

After the catwhisker is fastened to the mineral and the detector has been tested,

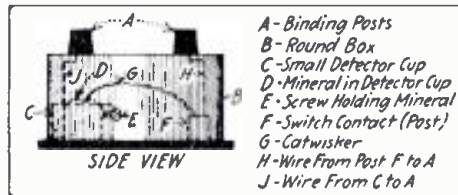

A Detector of This Type Requires No Adjustment, as the Contact Point and Crystal Are Enclosed in Sealing Wax.

pour sealing wax over the detector until it is entirely covered.

Glue the cover on the box and you have a sealed detector.

Contributed by CHAS. H. STEIGER.

## AN AUDION FOR THE AMATEUR.

For the benefit of those with scant pocketbooks or those wishing to experiment, I have tried to make a vacuum tube out of the ordinary odds and ends found about any shop. The main difficulty in making a tube is getting a good vacuum, which is very difficult unless one has the necessary apparatus. As may be seen in the drawing, the outer tube is an ordinary test tube about 6" x 3/4". It may seem a bit long, but I would not advise cutting it off, as it is very fragile and apt to break. The plate is made from a thin strip of aluminum about 1/2" wide. It is bent into shape and a connection taken off. The grid is a piece of bare copper wire about No. 14 B. and S. The filament is a spiral form of No. 32 B. and S. wire. Now seal the grid in tight with sealing wax and leave the lead from it free. Next the filament is sealed in, great pains being taken not to leave it touch the plate or grid. Next a thin piece of glass tubing in the end of the tube as shown in the drawing. The whole open end should be sealed up tight to prevent leaks. It may be tested by putting the test tube under water and blowing in the open tube. Air bubbles will form around the leaks. Now take a Bunsen burner and put on the fish-

tail attachment. Draw all the air possible out of the tube by sucking on the glass tubing and let the flame play on the tubing

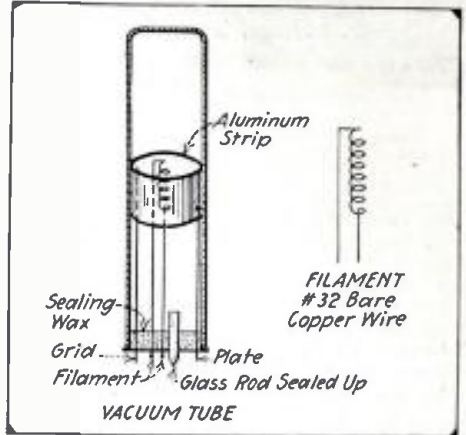

The Experimental Vacuum Tube of This Type May Be Easily Constructed. Note the Filament, Grid and Plate Are Supported in the Sealing Wax.

about a half an inch from the wax. Seal the tube up close to the wax, being sure the heat is distributed evenly over the tubing or else it will sag and seal unevenly. It may help to heat the test tube slightly while drawing the air out as the air will expand. While this type of tube will not last very long, it will give good results, and if good care is taken of it, it will work in fine style.

Contributed by JAMES DE LANEY.

## A CABINET LOOSE COUPLER.

As everybody is trying to make their apparatus in the form of cabinets, the following suggestion is made:

Why not, in making your loose coupler in the form of a cabinet, instead of leaving off part of the front (so you can slide the secondary), enclose the whole coupler and cut a slot shown at "A" in Fig. 1. Next extend secondary switch knob "B" through this slot and attach a pointer to it. Then draw lines on the cabinet front parallel to the slot. They are drawn both above and below the slot corresponding to the switch contacts so that the pointer shows which contact the secondary switch blade rests upon; now number the lines with relation to the switch points.

Fig. 2 shows the arrangement of the secondary switch: "A" is the knob, "B" is the pointer, "C" is the rod connecting switch contacts so that the pointer shows switch points, "E" is a semi-circular piece of hard rubber fastened endwise to the end of the secondary. This piece has the secondary switch mounted on it; "F" is an L-shaped bearing that the switch rod works in. It helps to make the sliding action rigid. "GG" are the sliding rods which support the secondary.

Contributed by

J. L. EGBERT.

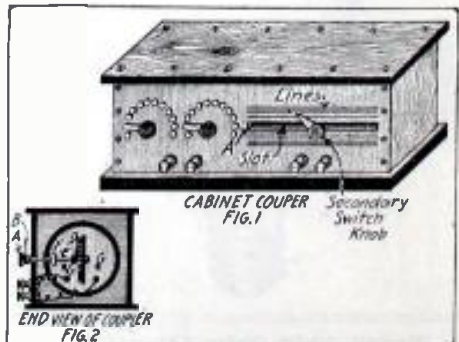

Method of Mounting a Loose Coupler in a Cabinet. Note the Switch Control.



# NEW RADIO PATENTS

**Radio Receiving Apparatus.**  
(No. 1,306,474, issued to A. N. Edmonds.)  
This invention relates to new and useful improvements in apparatus for transmitting intelligence by ra-

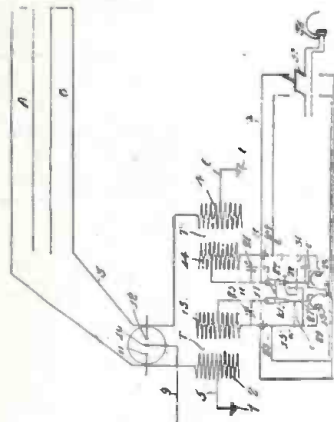

1,306,474

diant energy, and has for its primary object the provision of a device of this character whereby a plurality of messages of different wave lengths may be received at one station, and means are also provided whereby the operators receiving the messages may verify their messages by "listening in."

In operation, let it be assumed, that there are two messages being sent from distant stations and it is desired that such messages be received in their entirety at the station represented by the diagrams in the drawings. To receive a plurality of messages the switch S is allowed to remain in the position shown in the figure, the switch 31 being maintained in the open position, as shown in this figure. The tuning coils T and T' are now adjusted to receive messages on the antennae A and B, it being, of course, assumed that the messages being received are of different wave lengths, the usual adjustments may be made in the detectors 23 and 24 and the condensers 25 and 26, these circuits being controllable entirely independently of one another. If a third operator desires to listen-in on either of the messages being received, he may do so by moving the arm of the switch 33 into connection with one or the other of the circuits x and y.

Assuming that it is desired to receive a message of distress or the like the switch S may be moved to the right. The switch 31 is moved to the closed position which places the receivers 19 and 20 in series. In this position the message sent will be received through the tuning coil T. To receive a message independently of the tuning coil T the switch S is moved to the left. It will thus be seen that messages of different wave lengths may be simultaneously received by an improved system, or very important messages may be received and verified by the two receivers being connected in series. It will also be noted that when it is desired to send a message the anchor spark gap comprising the terminals 10, 11 and 12 is provided to allow the use of both antennae, which, of course, gives a wider area from which the message may be delivered.

**Antenna for Wireless Distribution Systems.**  
(No. 1,305,104, issued to P. C. Hewitt.)

The object of the invention is to increase the radiating power of an

aerial by means of increasing the voltage to which the aerial may be raised without loss due to corona effect. The invention consists in constructing the diameter of the aerial along its length and its various parts in direct relation to the voltage which the aerial at any point is required to sustain.

The invention itself is embodied in an aerial having an increasing diameter from the conductors used at the ground end, to a diameter of 6 inches, or thereabout, at the terminal end. The end should be insulated by means of an insulator in practically the same manner and of substantially the same construction as high voltage transmission lines are now insulated. With such an arrangement the terminal voltage to which the aerial may be operated without corona effect or leakage loss may be, or may even exceed, 600,000 volts, while with the ordinary wire and insulator the corona loss incident thereto may be attained below 100,000 volts, thereby rendering operation impractical at such high voltage. The energy that may be radiated from an aerial increases in some direct ratio as the operating voltage of the aerial is increased.

The aerial may be constructed of flat wire, woven basket fashion, so as to be 6 inches in diameter at the end, or it may be made bird-cage fashion of wires held close together, or be made of sheet metal, or otherwise fashioned. For convenience, the aerial may at parts of its length be larger in diameter than as herein described as necessary, but should not be smaller, except that it has electro-static effect imposed on it as would be the case in internal convolutions of a spiral.

The invention is illustrated in the accompanying drawings, in which

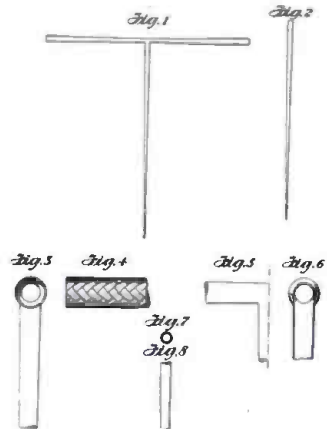

1,305,104

Figs. 1, 2, 3, 4, 5, 6, 7, and 8 show various forms of construction of the antenna.

**Wireless Signaling System**  
(No. 1,309,459, issued by John Rlarson.)

The object of this invention is to provide a system of wireless communication whereby secret communications between stations may be had to the end that stations, other than that designed to receive, may not receive complete, intelligible signals.

Heretofore, signals both in wireless telegraphy and telephony have been transmitted by means of electromagnetic waves of a definite high frequency or wave length and any station tuned to the wave length of said signals is capable of receiving said signals. In such systems secret communication can only be had by the employment of a secret code.

In the invention secrecy is obtained by the transmission of signals on a plurality of waves of different frequencies, successive portions of a message being transmitted on waves of different frequencies,

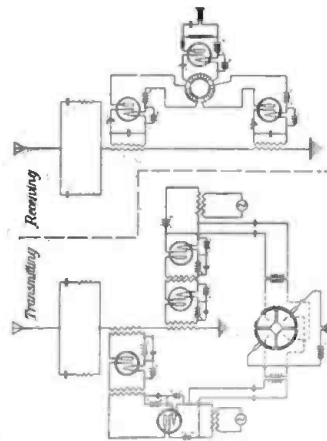

1,309,459

whereby a station tuned to one of said waves receives only a partial and therefore unintelligible disclosure of the communication. The invention may be employed in connection with any wireless signaling system but is particularly adapted for use with a wireless telephone system.

**Wireless Telegraphy**  
(No. 889,791, issued to S. Kitsee.)

The invention has more special reference to a receiving device adapted to expand or inflame through the incoming impulses a gaseous medium, and has for its object to provide means for assisting the incoming impulses to expand or inflame said medium.

The drawing illustrates in partially plan and partially sectional view the invention, the electric circuit being in diagram.

13 is the explosive chamber provided with the valves 14 and 15 and the inlet pipe 7. A localized circuit comprising the wire 17, battery 19, electro-magnet 20, wire 18, and adjustable contact 16, is in operative relation to the valve 15. The explosive chamber is provided with the terminal 21 in electrical connection with the terminal 11 of the transmitting circuit. The terminals 8 and 9 are connected respectively to the wires 22 and 26. To these wires are connected the secondaries 23 and 25, joined together through wire 24 and this wire is grounded through 12. The secondary 23 is provided with the primary 27 and the secondary 25 with the primary 28. The operation of this part of the arrangement is as follows: Normally, an interrupted or alternating current is past through the primaries 27 and 28, thereby generating alternating or rapidly recurring impulses in 23 and 25. These impulses should not be sufficient to produce a spark between 8 and 9, but they should be of sufficient

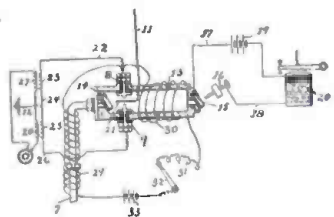

889,791

strength, so as to enforce the impulse coming through 11 and going from 21 either to 8 or 9, as the case may be. With the aid of this arrangement, it is possible to so enforce the incoming impulses that the same—no matter if originally too weak to produce the necessary spark of high temperature—can be used to explode the gas or other medium contained in the chamber 13.

To raise the explosive medium, such as a gas, to a temperature short of the explosive temperature, the inventor has provided the inlet pipe 7, as well as the explosive chamber, with the heating coil and designates this coil by the numerals 29 and 30. In the circuit of this coil is a source of current, here shown as the battery 33, and the variable resistance designated by the numeral 31 and its lever by the numeral 32.

It is obvious that instead of heating the gas with the aid of this electric current, other means may be provided for this purpose, but it is believed that this arrangement, as outlined in the drawing, is preferable, because it is possible therewith to maintain an even temperature throughout the operation.

**Wireless Signaling System.**  
(No. 1,313,042, issued to E. F. W. Alexanderson.)

The present invention relates to wireless signaling systems, and more particularly to a so-called "duplex system" in which means is provided for simultaneously sending and receiving messages at a single station.

The object of the invention is to provide means for neutralizing in the receiving circuit or apparatus the effect of waves which are being

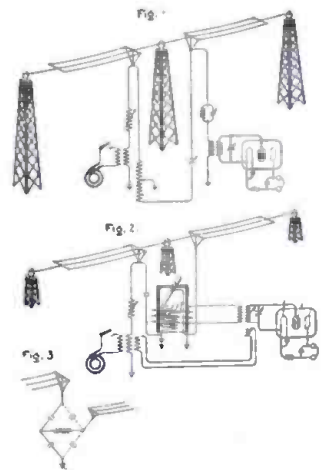

1,313,042

transmitted from the same station. In carrying the invention into effect the inventor employs separate antennae for transmitting and receiving purposes. Both of these antennae may be suspended from the same towers in whole or in part, or may be located in fairly close proximity to each other upon separate towers. In order to overcome the effect in the receiving apparatus of the waves impressed upon the receiving antenna from the transmitting antenna there is derived from the transmitting antenna an electromotive force equal in value and opposite in direction to the potential induced upon the receiving antenna from the transmitting antenna and this electromotive force is impressed upon the receiving circuit in such a manner as to neutralize in the receiving apparatus the effect of the induced potential.



**T**HIS Department is conducted for the benefit of our Radio Experimenters. We shall be glad to answer here questions for the benefit of all, but we can only publish such matter of sufficient interest to all.

1. This Department cannot answer more than three questions for each correspondent.
2. Only one side of the sheet should be written upon; all matter should be typewritten or else written in ink. No attention paid to penciled matter.
3. Sketches, diagrams, etc., must be on separate sheets. This Department does not answer questions by mail free of charge.
4. Our Editors will be glad to answer any letter at the rate of 25c for each question. If, however, questions entail considerable research work, intricate calculations, patent research, etc., a special charge will be made. Before we answer such questions, correspondents will be informed as to the price charge.

You will do the Editors a personal favor if you make your letter as brief as possible.

**UNDAMPT RECEPTION.**

(120) Kenneth Latts, Rogers, Arkansas, asks:

Q. 1. Could I use a 3,500 meter loose coupler, 43 plate variable condenser, Galena detector, 2,000 ohm phones, large load-

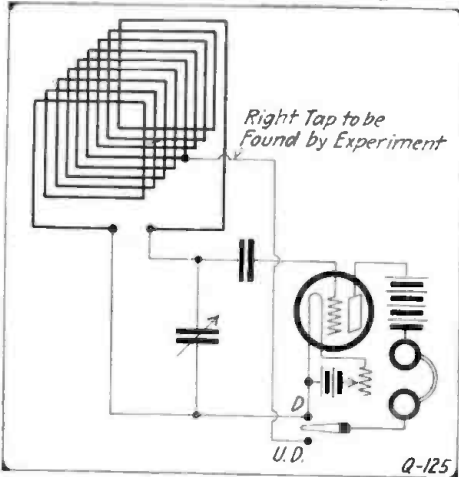

This Shows the Hook-Up for Using the Loop Antenna in Connection With the Feed Back Circuit.

ing coil, small fixed condenser (shunted in phone circuit) for the receiving of damp and undamp waves?

A. 1. No. In order to receive undamp signals some sort of detector must be used which will reduce the high frequency signals to an audible frequency. See question 109 elsewhere on these pages.

**LOOP ANTENNA.**

(121) L. D. Jones, of N. B., Canada, wants to know:

Q. 1. I am much interested in the loop antenna and would like to know if No. 20 enameled wire would be suitable for a four-foot reel of 60 turns?

A. 1. Yes; No. 20 enameled wire is suitable for a loop antenna.

**VARIOMETER.**

(122) Irwin Moison, Blauvelt, N. Y., asks:

Q. 1. What is the natural wavelength of an aerial 200 ft. long, 50 ft. high, having a 70-foot lead-in?

A. 1. Approximately 850 meters.  
Q. 2. I wish to make a variometer. What size wire should I use to wind it?  
A. 2. The size wire depends upon the

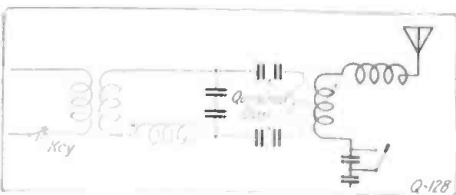

Here is Shown a Type of Impulse Transmitter Circuit.

circuit the variometer is intended for. See article on variometers in this issue.

**LENGTH OF AERIAL.**

(123) E. A. Harvey, of Lancaster, Pa., desires to know:

Q. 1. I have 400 ft. of wire to use in putting up an antenna. What would you advise; 4 wires 100 ft. long or 2 wires 200 ft. long?

A. 1. 2 wires 200 ft. long. Of course this would be for receiving only.

**AMPLIFYING TRANSFORMER.**

(124) James Russel, N. Y. City, asks:

Q. 1. How could one make the instrument which is shown in most audion diagrams which inductively connects the receiver to the amplifier?

A. 1. A book, "The Design and Construction of Audion Amplifying Transformers," written by E. T. Jones, is just off the press. It contains full information for making several types of these transformers. Our book department will mail it for 25 cents.

Q. 2. Is it a step-up or step-down transformer?

A. 2. A step-up transformer.

**LOOP ANTENNA.**

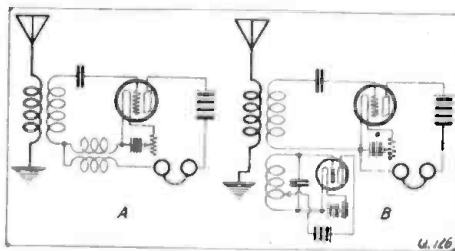

The Circuit Shown in A is Self-Heterodyning, While in B an External Oscillator is Used.

(125) John Wohl, Chicago, Ill., asks the following:

Q. 1. Please tell me the kind and size of wire to use on a 4-foot square loop antenna?

A. 1. Ordinary No. 18 bell wire should give excellent results.

Q. 2. A hook-up for the following: Marconi-De Forest, VT. and accessories, a .001 mfd. variable condenser, a large loop antenna.

A. 2. Hook-up given herewith.  
Q. 3. Using the hook-up of C. Fig. 4, on page 120 of the September RADIO AMATEUR NEWS, what voltage should be the "B" battery have in order to use this circuit for a radiophone transmitter?  
A. 3. About 350 volts.

**LOCAL BEAT RECEIVER.**

(126) James McCrady, Boston, Mass., asks:

Q. 1. Which is the best circuit for the reception of undamped waves, the one shown in "A" or the one in "B" which uses an external beat receiver?

A. 1. The circuit shown in "B" is the most efficient.

Q. 2. Which is more efficient audio or radio frequency amplification?

A. 2. Radio frequency amplification is

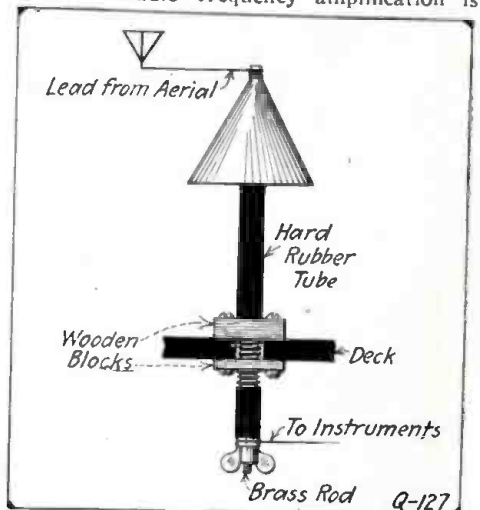

The Bradfield Insulator Consists of a Hard Rubber Tube Which Extends Through the Deck and Fastened as Shown. Connection From the Aerial to the Instrument is Made Through a Metal Rod Extending Through the Tube.

far more efficient. See article in this issue on Armstrong super-antodyne amplifier.

**BRADFIELD INSULATOR.**

(127) Kenneth Barnard, Syracuse, N. Y., desires to know:

Q. 1. What is a Bradfield insulator and what does it look like?

A. 1. The Bradfield insulator is used mostly on ships. As shown in the illustration the insulator consists of a long, hard rubber tube about 2 inches in diameter, and thru this tube a brass rod is extended. On each side of the deck or cabin roof a wooden block is mounted with wood screws. The metal hood is used to protect the exposed end of the tube from dampness.

**IMPULSE TRANSMITTER.**

(128) Harold Higgins, of Bridgeport, Conn., asks:

Q. 1. Please give diagram of an impulse transmitter circuit.

A. 1. A good circuit is shown in these columns.

Q. 2. What is meant by aperiodic?  
A. 2. Aperiodic or non-periodic means  
(Continued on page 447)

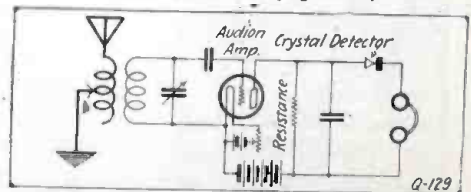

This Shows the Simplest Method for Using an Audion as an Amplifier and a Crystal for a Detector.

# MURDOCK No. 55

IN APPEARANCE  
THESE 'PHONES  
SATISFY THE RE-  
QUIREMENTS OF  
THE MOST CRIT-  
ICAL.

IN OPERATION  
THESE 'PHONES  
SURPASS IN SENSI-  
TIVENESS THE EX-  
PECTATIONS OF  
THE MOST OPTI-  
MISTIC.

2000  
OHM  
COMPLETE  
DOUBLE SET  
**\$4.50**

3000  
OHM  
COMPLETE  
DOUBLE SET  
**\$5.50**



IN DURABILITY,  
THESE 'PHONES  
WILL SERVE AS  
LONG OR LONGER  
THAN ANY.

IN RELIABILITY,  
THESE 'PHONES  
YIELD TO NONE,  
THEIR CONSTRUC-  
TION INSURING  
"ALL - THE - TIME"  
SERVICE.

## RIGHT IN PRICE AND IN PERFORMANCE

The substantial success earned by these receivers can be attributed to the instant recognition and acknowledgment of their remarkable value, by thousands of users. If, by chance, you are not acquainted with their merits, or are dubious regarding the possibility of securing really good 'phones at such prices, we suggest a trial, with the customary assurance of "satisfaction or money back."

Our Bulletin No. 19B Illustrates and describes the Complete Line of Reasonably Priced  
**MURDOCK APPARATUS.** A Copy Will Be Sent at Your Request.

## WM. J. MURDOCK CO.

50 CARTER ST.

CHELSEA (BOSTON 50) MASS.

509 MISSION STREET,

SAN FRANCISCO, CAL.

*You benefit by mentioning the "Radio Amateur News" when writing to advertisers.*

## Everything You Want To Know About A. C. Motors

Is found instantly in the **ELECTRICAL WORKER'S FRIEND**. The only complete book of its kind for the man on the job or the student. Will make you an expert motor repairman. Contains 86 electric motor drawings with complete instructions for rewinding and reconnecting. Tells how to put each coil in the slots, how to get speed, alternations, cycles, poles, how to find the coil throw, number of coils per group and number of groups, etc.

Covers all practical reconnecting changes from one phase to another, from one voltage to another, or changing both the phase and voltage at the same time.

Written so you will understand it. You need this book—send for a copy today.

**\$4.00** or we will ship  
C. O. D. if you prefer

Free Circular on Request

**Henry F. Bosshart**

P. O. Box 68, Homewood Sta., Pittsburg, Pa.

## LEARN THE AUTOMOBILE BUSINESS

Great opportunities for trained men as Motor Experts, Shop Foremen, Licensed Chauffeurs, or in business for yourself.

**YOU CAN EARN \$100 to \$400 Per Month**

You learn here by putting on overalls and doing the actual work, under expert instructors. By this method you cannot fail. If you have yearned for a future where you can make big money—here it is.

Write TODAY for information

**BUFFALO AUTO SCHOOL**

Dept. 86 Buffalo, N. Y.

## GLIDE "O" PLANE



Learn the principles of Aviation by flying our famous glide O plane. Not a toy, but a scientifically constructed gliding model, which may be thrown by hand on the field or launched from the top of the hill. Will circle, loop and glide gracefully with a light throw. Constructed of best materials, finished in bright colors with the insignia of the U. S. Army on the Main Plane.

Very durable and easy to fly. All wood, adjustable. Price 55c Postpaid in U. S. Send for catalogue H3.

HEC Aeroplane Co., 345 E. 49th St., New York City

## POPULARITY FOLLOWS THE UKULELE

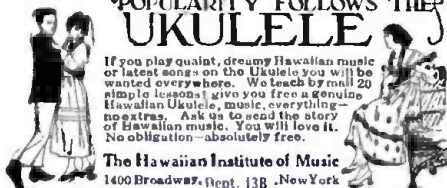

If you play quaint, dreamy Hawaiian music or latest songs on the Ukulele you will be wanted everywhere. We teach by mail 20 simple lessons that give you free a genuine Hawaiian Ukulele, music, everything—no strings. Ask us to send the story of Hawaiian music. You will love it. No obligation—absolutely free.

The Hawaiian Institute of Music  
1400 Broadway, Dept. 138, New York

## ACROMATIC TELESCOPE



Made upon new scientific principles, nicely brass bound with powerful lenses, scientifically ground. Travelers, hunters, farmers, boy scouts and everyone needs a telescope. Have you ever enjoyed the marvels of a telescope? Each telescope guaranteed just as represented, or money promptly refunded. Send 99 cents to-day. EASTERN NOVELTY CO., Dep. 70 177 E. 93 St., New York

## STAMMER

If you stammer attend no stammering school till you get my big new FREE book and special rate. Largest and most successful school in the world curing all forms of defective speech by advanced natural method. Write today. North-Western School for Stammerers, Inc., 2366 Grand Ave., Milwaukee, Wis.

## CAMERAS—LOWEST PRICES

Supplies and printing at reduced prices. Eliminate the middleman. Deal direct and save money. Catalog Free. Pearl Photo Place, 640 E. Clementine St., Philadelphia, Pa.

## The Radio Compass

(Continued from page 402)

leader, and radio measurements in particular have been very highly developed by this institution during the last few years. Take the matter of the insulating materials used in all electrical apparatus. All the conductors, condensers, switches, and other apparatus must be mounted on some insulating base, and there is no material which, being never affected by any of the electrical actions, is satisfactory in every respect. Consequently, the exact behavior of these materials when the high-frequency and voltage of radio currents are acting, must be known. Highly specialized equipments have been built for performing these tests, and the methods of measurement carefully worked out.

### THOUSANDS OF MEN TRAINED IN RADIO COMMUNICATION.

One of the great war problems in the use of radio apparatus was the training of men. Instead of a few scores of trained radio operators and a handful of experienced radio engineers, as we had before the war, there was immediate need for thousands of men skilled in this work. We all know something of the intensive training carried on at the cantonments and in the schools designated by the War Department throughout the country. In this subject of radio communication an acute need for suitable instruction literature was felt by the men secured to act as instructors everywhere. In this matter the Signal Corps secured the aid of the Bureau of Standards. Two textbooks were prepared by a syndicate scheme of authorship, an innovation in the preparation of scientific textbooks. An instruction book was needed which should train men of limited education to become familiar with the principles of radio apparatus in a few weeks. This was made ready in three months by the plan mentioned, concentrating on the task the efforts of a number of experts and instructors from various large universities. An order for 50,000 copies of this book, *The Principles Underlying Radio Communication*, was placed by the Signal Corps, the number later being cut down because of the signing of the armistice. The book is an easily read introduction to radio theory and practice. There was also need of a somewhat more advanced reference book which would be of assistance to the instructors and to the students training for officers in charge of radio work. This also was provided by the Bureau of Standards. It is a book which gives the principles of the subject, methods, and data for calculations and measurements of all kinds. This book, entitled *Radio Instruments and Measurements*, has been used to train 4,000 men in the technical phases of radio work. These two textbooks in a rapidly advancing subject are strictly up-to-date, and for practical purposes retire a considerable proportion of previous radio literature.

### THE MARVELOUS ELECTRON TUBES AND THEIR USES.

Much has been rumored in recent newspaper articles regarding the radio telephone used on airplanes. This achievement is entirely a product of the research work which has been done on the interesting little glass bottles known as electron tubes. These tubes are similar in appearance to an ordinary incandescent lamp bulb. Like the incandescent lamp, they contain a heated filament, and, in addition, two metal terminals. The principle upon which they operate is that a stream of exceedingly small electrical particles called electrons are given off by every body at a high temperature. The motion of this stream of electrons from the filament to the other two metal terminals in the bulb or tube is con-

trolled by the batteries and other apparatus connected outside the tube. This device was invented less than ten years ago, and most of its development has been accomplished during the war. It is a most wonderful instrument and, in fact, serves as the detector of radio waves, as a very powerful amplifier of radio or any other electrical currents, as a generator or producer of radio waves, and as the means for converting speech into a modulated radio wave which can be received as speech by a receiving radio apparatus. Not much needs to be said to convince the reader that these important applications justify the most extensive and profound research, development, and application. Thus the principal work of the great New Jersey radio laboratories of the Signal Corps was the development of these electron tubes. Certain research work and the standardizing of tubes and methods of testing were assigned to the Bureau of Standards. The principles of the operating and functioning of the tubes are, by contrast with the structure of the tubes themselves, complicated and difficult to determine. Compared with extensive applications of these devices which have already been made but little is known regarding the principles of their operation.

Their importance in military work may readily be judged from the fact that for the American armies alone 25,000 tubes were being made each week. These devices are revolutionizing all branches of radio and bringing with them many advantages which investigators have sought for years, and sought in vain, with other forms of apparatus. Outside of radio they have many applications. A noteworthy one is the adaptation to multiplex telephony. They make possible the use of a single pair of wires for five simultaneous telephone conversations. On account of their great sensitiveness as receiving devices radio apparatus can be made small. These devices in fact must be credited with a considerable share in the achievement mentioned above in describing direction finders, namely, receiving messages from a distance of thousands of miles with a small apparatus contained in an ordinary room. Apparatus capable of concealment about a person's clothing may now be had, by which one can receive the radio messages which are passing through space. The day will no doubt come when a complete radio outfit can be carried much as a wrist watch is carried at present.

### RADIO TELEPHONY NOW AVAILABLE FOR THE AEROPLANE.

The electron tube has made communication between airplanes successful. Obviously airplane apparatus must go the limit of light weight. This is possible with the very sensitive electron tubes. Airplane pilots now talk to one another, using apparatus that adds only a few pounds to the weight of the machine. Best of all, the results of this achievement are now available for peace-time use. A person may pick up the telephone receiver in his house any day now and after he has conversed with someone, may learn that the person at the other end was in the air on an airplane during the conversation, for not only can the communication be carried on from an airplane to a ground radio set, but the apparatus can be connected to the ordinary telephone lines. The radio telephone was among the apparatus brought by the French Scientific Mission to this country in 1917. Improvements in many points have been made since then and have made the apparatus much more reliable and effective. The telephone instruments used on the airplane are of special kind. Thus the transmitter is so made that it is affected by the voice of the aviator but not at all by the noise of the airplane's engine; the receiver is contained in the helmet which the aviator wears, in which there are pads over the

You benefit by mentioning the "Radio Amateur News" when writing to advertisers.



Write for folder giving complete specifications and operating instructions.

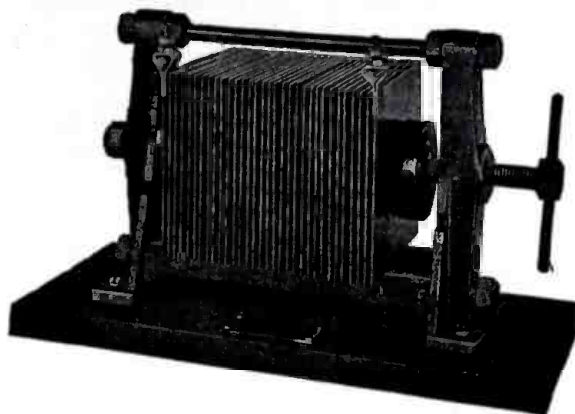

**\$17.50**

Shipping Weight  
12 lbs.

## More Working Energy in Your Antenna!

You must have proper quenching in your primary circuit if your antenna is to radiate all its energy and not transfer current back to the primary condenser circuit, where it is lost. With the

### “AMRAD” QUENCHED GAP

you have perfect quenching—with no rotating parts to give trouble, and no motor to eat up current—and you get

### A 240-SPARK NOTE ON 60 CYCLES

with a low decrement entirely inside Government regulations. This instrument gives as satisfactory service as the more expensive silver-surfaced quenched gaps, because the plates are of electrolytically refined copper having practically the same thermal conductivity and gas content as silver.

Ample radiation capacity is afforded by the liberal area of the plates, and the airtightness of the sparking chambers is assured by the special method of assembly. All parts are interchangeable.

If your dealer cannot supply you, order direct of us, but send us his name.

### TUNE YOUR STATION FOR HIGHEST EFFICIENCY

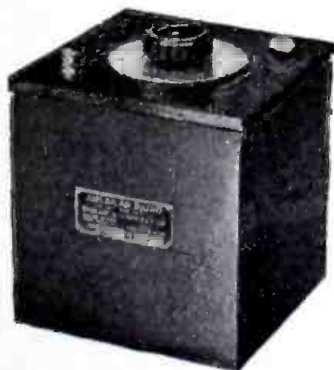

Shipping Weight 2 lbs.

and keep safely inside Government regulations.

You will have no tables or curves to bother with if you use the

### “AMRAD” WAVE METER

**\$6.50**

By means of a flashlight bulb and a direct-reading dial, this simple, reliable little device gives instantaneous, accurate measurement of your transmitting wave-length. Mounted in ebonized wood case, with Bakelite top plate—metal parts nicked. Descriptive folder on request. Ask your dealer—if he cannot supply you, we will ship direct to you.

### “AMRAD” DETECTOR STANDS



Duplex stand, on Bakelite base, with two selecting switches and two binding posts—\$4.50—shipping weight 1 lb.

Single stand, on Bakelite base, with two binding posts—\$2.50—shipping weight ¾ lb. Your dealer should be able to supply “Amrad” Detector Stands—if not, send us his name and order direct.

Folders describing any pieces of “Amrad” apparatus will be sent on request—write for them.

## AMERICAN RADIO AND RESEARCH CORPORATION

25 PARK ROW

NEW YORK

Factory at Medford Hillside, Mass.

# FREE



WE are giving away hundreds of expensive wireless instruments, electrical apparatus, supplies, etc., for selling a household article that goes like wild fire because it is a genuine necessity and because it sells so cheap. All of our premiums are guaranteed new and perfect. We give you no junk.

Plans to receive high grade wireless apparatus without costing you a cent should surely interest you. An opportunity such as this one may never again be placed before you so take our advice and grab it.

A very fortunate purchase permits us to sell a household article at the astonishingly low price of twenty-five cents a set, at which price they are irresistible. Their splendid value and attractiveness, their usefulness and their quick selling qualities will make them go like hot cakes. This article is a genuine necessity in each and every home.

Remember, you get these goods as a premium for selling the articles and sending us the money after they are sold. You don't have to pay a cent for them.

Send us your name and address and we will send you prepaid our catalogue to select your premium from, twelve household necessities, and all necessary information for selling, etc.

By continuing the sale of our goods you can receive some magnificent apparatus. Drop us a postal and leave the rest to us.

**BECK NOVELTY HOUSE**  
1298 Carroll Street, Brooklyn, N. Y.

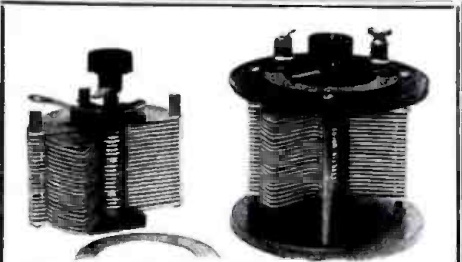

## THE "ILLINOIS" VARIABLE CONDENSER

Hard Rolled Aluminum Plates

Three Styles, No. 1, Panel, No. 2, Open Type as shown, No. 3, Fully Encased. Anti Profiteer. Less than pre-war prices. Fully assembled and tested.

Sent Prepaid on Receipt of Price

|             |        |        |                                                                                    |
|-------------|--------|--------|------------------------------------------------------------------------------------|
| Style No. 1 | No. 2  | No. 3  | Money back if not satisfied. Just return condenser within 10 days by insured P. P. |
| \$3.00      | \$3.50 | \$3.75 |                                                                                    |
| 2.50        | 3.00   | 3.25   |                                                                                    |
| 2.25        | 2.75   | 3.00   |                                                                                    |

These condensers are made by a watch mechanic schooled in accurate workmanship. Personally we will need no introduction to Amateurs who have "listened in" for "time" and "weather" from 9. ZS.

G. F. Johnson, 627 Black Ave., Springfield, Ill.

## Audiotron Adapter

### SOMETHING ENTIRELY NEW

The TeCo Specialists products Fits any four point standard socket. Note the price, don't be without one.

Pat. appl'd for. Price \$1.75

**The TeCo Radio Co.**  
P. O. Box 3362 Boston, Mass.



## A New VACUUM RECTIFIER TUBE for Wireless Telephone

absolutely the newest device on the market. Does away with motor generator. It permits you to use 110 VOLTS 60 CYCLES alternating current and rectifies this to direct current for the transmitting tube.

Get our free descriptive circular 13B

**WIRELESS EQUIPMENT CO., INC.**  
19 Park Place New York, N. Y.

## You can be quickly cured, if you STAMMER

Send 10 cents coin or stamps for 70-page book on Stammering and Stuttering, "Its Cause and Cure." It tells how I cured myself after stammering for 20 years.  
Benjamin N. Bogue, 855 Bonnie Bldg., Indianapolis

receivers to absorb engine sounds so that the feeble telephone noises can be heard.

## AN ALMOST UNLIMITED FIELD FOR RADIO TELEPHONY.

One of the interesting uses of the radio telephone was demonstrated at the Bureau of Standards a few weeks ago at an evening lecture and social meeting. The radio telephone apparatus was shown. Messages were transmitted and received by the device. In addition music was received in the lecture hall by radio from a talking machine which was being played at the transmitting station at a distance. Now the waves which carry this radio music spread out in all directions as do all radio waves. Consequently not only the receiving apparatus in the lecture room, but any receiving apparatus within a radius of several hundred miles was able to catch this music. In fact, after the demonstration, word was received that this music had been heard in another town. An unexpected result was obtained when after the music rendered by the talking machine had been finished "The Star Spangled Banner" was played by a cornetist at the transmitting station. The audience in the lecture room immediately arose and after the performance applauded. The performer never knew that the applause had been given and never knew whether his performance had even been heard. Later in the same evening some of the people danced to the same music. This suggests the great economies that will be effected in the future in the matter of musical entertainments. A symphony orchestra or any other musical performance can be given at one central point and sent forth by radio so that it can be received anywhere else in the United States. One performance then will constitute the evening's entertainment for the whole country. This is Edward Bellamy's dream come true.

Out of the wreck of war much of what was done in the application of science is being salvaged, more perhaps than is ordinarily realized. In the great development of radio communication there is a distinct asset which is now being turned to the peaceful uses of mankind. Radio is not so much a separate as a supplementary means of communication. The ordinary wire-connected telephone will handle 99 per cent of the exchange of speech, and the radio telephone will supplement it, carrying men's words and thoughts to the uttermost parts of the earth, air, and sea.—*The Federal Employee.*

## NEW KEYPORT WIRELESS STATION

The largest and most powerful wireless station on the Pacific coast, commanding sufficient power to communicate with Hawaii, Alaska and probably the Orient, will be in operation early next year at Keyport, Wash., across Puget Sound from Seattle.

The station, towering 400 feet in height, was ordered built by the United States Bureau of Yards and Docks of the Navy.

The station will be completed within 180 days. The structure will be of steel, 90 feet in diameter at its base and 5 feet at the apex of the 400-foot tower. The contract also calls for the wiring of the station, but Government radio experts will install the radio apparatus.

Establishment of the Keyport station will assist materially coastwise, trans-pacific and Alaska shipping, and the project will be a valuable addition to the naval strength of Puget Sound.

## A Modified Government Receptor

(Continued from page 410)

the author in the November issue of the RADIO AMATEUR NEWS.

It is not the writer's intention to give any set instructions for the mounting of this set as they would not be strictly adhered to by the individual constructor. A few constructional suggestions, however, may not be amiss.

The coils should be mounted with a distance of four inches between centers with the secondary in the middle. Allow a full 180 degrees swing for the tickler coil as the regenerative coupling seems to vary a great deal between the shortest and the longest waves. Almost invariably the coupling for the shorter waves will be almost 180 degrees; opposite to that for the longer waves. As the coils are pivoted in the middle there will be no need of friction bearings and counterweights such as are seen in many sets.

Most any of the variable condensers sold by dealers for back mounting will serve the purpose if it has a capacity between .0009 and .001 mfd. but it is best to choose one of heavy construction if the dials are expected to keep accurately calibrated for any length of time. The best method of mounting the dials is to screw them to a brass flange and allow the screws to extend thru into the hardrubber knob. The flange, dial, and knob are then slipped over the extended condenser shaft and held in place with a set screw.

The wave switch is simply the switch of Fig. 4 screwed to the panel. If mounted in this way the panel may constitute one bearing of the switch.

If the builder does not care to wind the two winding coils as required for this set he may easily substitute the honeycomb inductances that are now on the market. It might be well to note at this point that the mounting furnished by the manufacturer furnishes far closer coupling than is necessary for long wave reception and that honeycomb coils mounted similarly to those shown in the photograph give ample satisfaction when receiving long, undamped waves.

With the preceding information at hand there is no reason why any one with a little ingenuity should not be able to construct a fine receptor that compares with the best government apparatus. The writer will vouch for good results if the windings are wound as specified.

## WIRELESS TELEPHONY IN EUROPE

As the business of the air becomes a power to be reckoned with, the wireless telephone will play a very important part in inter-communication. It is already being used by the British in their aerial lines. The Air Ministry, as a step to avoid confusion in sending messages, issued the following regulation: "The radio-telephony stations at the airdromes at Hounslow and Lympne are now working on 900 metre wave-length. The registration marks of aircraft should be used as the call signs in making or receiving signals by wireless telegraphy or other methods of communication, except when opening up communications by means of visual signals, when the usual methods will be employed. The "Airco" mail carrying London-Paris airplanes are now equipped with improved wireless telephone installations by which the pilots can keep in touch with both the London and Paris terminals while in flight.

It is possible by means of a chart kept at the terminal offices to see the position of every one of the company's airplanes at a glance.

You benefit by mentioning the "Radio Amateur News" when writing to advertisers.

# LEARN WIRELESS AT HOME

## The Demand for Wireless Operators Far Exceeds the Supply

The New York Wireless Institute will make you an operator—AT HOME—in your spare time—quickly, easily and thoroughly. No previous training or experience required. Our Home Study Course has been prepared by Radio Experts. Experts able to impart their practical and technical knowledge to YOU in an easy to understand way. The graded lessons mailed you will prove so fascinating that you will be eager for the next one. The instruments furnished free, will make it as easy to learn the Code as it was to learn to talk. All you will have to do, is to listen.

### Big Salaries

Wireless operators receive excellent salaries ranging from \$125 to \$200 a month and it is only a stepping stone to better positions. There is practically no limit to your earning power. Men who but yesterday were Wireless Operators are now holding positions as Radio Engineers, Radio Inspectors, Radio Salesmen at salaries up to \$5000 a year.

### Travel the World Over

A Wireless Operator can visit all parts of the world and receive fine pay and maintenance at the same time. Do you prefer a steady position without travel? There are many opportunities at the numerous land stations or with the Commercial Wireless or with the Steamship Companies.

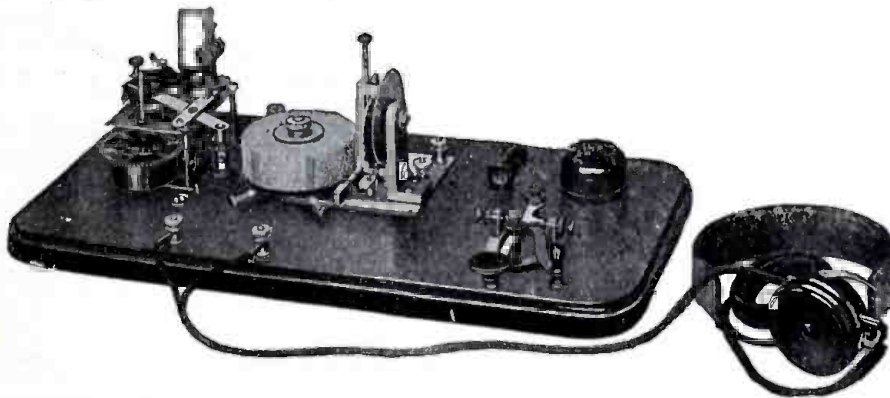

This wonderful Set for learning the Code furnished free with our Course

### FREE Instruments and Text Books

We furnish free to all students, during the course, the wonderful receiving and sending set exactly as produced in the illustration. This set is not loaned, but given to all students completing the Course.

The Transmitter shown is the celebrated *Omnigraph* used by several Departments of the U. S. Government and by the leading Universities, Colleges, Technical and Telegraph Schools throughout the U. S. and Canada. Start the *Omnigraph*, place the phone to your ear and this remarkable invention will send you Wireless Messages, the same as though you were receiving them, through the air, from a Wireless Station hundreds of miles away. When you apply for your license, the U. S. Government will test you with the *Omnigraph*—the same model *Omnigraph* as we furnish to our students. Ask any U. S. Radio Inspector to verify this.

### FREE Post-Graduate Course

A one month's Post-Graduate Course, if you so desire, at one of the largest Wireless Schools in N. Y. City. New York—the Wonder City—the largest port in the World and the Headquarters of every leading Wireless and Steamship Company.

### Easy Payments

A small payment down will enroll you. We will make the payments so easy that anyone ambitious to enter the fastest growing profession—Wireless—may do so.

### Send for FREE Booklet

Without obligating you in any way, send for our booklet "How to Become an Expert Wireless Operator"—it is free. Mail the coupon below, or postal or letter—but do it today.

### NEW YORK WIRELESS INSTITUTE

Dept. 71, 258 Broadway,

New York City

New York Wireless Institute  
Dept. 71, 258 B'way, N. Y. City

Send me free of charge, your booklet "How to Become an Expert Wireless Operator," containing full particulars of your Course, including your Free Instrument Offer.

Name .....

Address .....

City or Town..... State.....

You benefit by mentioning the "Radio Amateur News" when writing to advertisers.

## Make Your Own WIRELESS APPARATUS



### SAVE 1/2

It's easy to make your own at home with the aid of these 4 up-to-date books that you can understand. Each has over 72 pages and over 60 illustrations, 3 color cover, size 5 x 7 inches.

**LESSONS IN WIRELESS TELEGRAPHY** is a course in the elementary principles which you must understand to obtain good results. **WIRELESS CONSTRUCTION AND INSTALLATION FOR BEGINNERS** gives complete details with working drawings for making simple but good sending and receiving apparatus and erecting aeriads, etc.

**THE OPERATION OF WIRELESS TELEGRAPH APPARATUS** shows how to obtain best results and greatest ranges with all kinds of apparatus, how to tune the station to 200 meters, use a wave meter, apply for license, etc.

**EXPERIMENTAL WIRELESS CONSTRUCTION** gives details, with working drawings for making more elaborate and efficient sending and receiving apparatus, complete sets, etc.

**35c.** each any **\$1.00**  
postpaid **THREE**

Less than the price of one telephone receiver. Order now while the supply lasts.

**COLE & MORGAN, Inc., Publishers**  
Dept. 112, 19 Park Place, New York

## ATLANTIC RADIO CO.

Our line of new apparatus comprises the latest post-war equipment.

Prepare your station for the new era in the amateur radio world by equipping with our standard, high grade apparatus, parts and supplies.

34 Battery March  
Street

BOSTON  
MASS.

## Switch Points FREE!

For five cents, to cover cost of packing and mailing, we will send one nicked switch point and nut free. If requested this amount credited on first order for two dozen at regular price of

35c per dozen.

These points are same type as used on first-class commercial apparatus, measuring approximately as follows—

Head 1/4"x1/4" Shank No. 6x3/4" screw.

Catalogue for postal.

**Toledo Radio Specialties Co.**  
Box 343 Old P. O. Toledo, Ohio.

## ADVERTISING PAYS

It pays the man who advertises and it pays the man who answers ads. For advertising rates in the Radio News, **ADVERTISING DEPT., 233 FULTON ST., N. Y.**

## The Priess Loop Set Part III.

(Continued from page 406)

for the convenient reading of plate battery voltage. The voltmeter is provided with spring type leads. A spare 20-volt battery is carried in the spare parts compartment.

(Article No. 4 in this series will describe special features of the Priess Loop Set including the Buzzer Transformer, the Regenerative Receiver and the Loop.)

### ARC TRANSMITTER.

Often experimenters desire a makeshift arc in experimenting with the various form of arc circuits for transmitters. Here is an arc, which altho it does not give as good results as the cooled arc, it is efficient enough to transmit fairly well.

An old motion picture lamp house was secured for practically nothing and used for the arc. The lamp house should be secured to some stationary base or support other than the original sliding support provided. If the lamp house does not have a red aperture thru which to view the adjustment of the arc, it should be provided with one made by the experimenter, as it is really essential in order to protect the eyes and to adjust the arc to the best position.

When operating the arc on a 110 v. current, the amperage should be limited to 5 amps. and the voltage cut down to 60 v. by means of a simple water rheostat, or by a choke coil. The latter is more efficient and should be used if possible.

If the arc is to be used on the above current, (110 v. 5 amp.) smaller carbons than are regularly used in the motion picture projectors should be used, for the larger carbons are usually operated on a current of about 20-30 amps.

Contributed by PHILIP A. WALL.

### GRAINING FORMICA AND BAKELITE.

Appearance counts a great deal in the makeup of a set. A cabinet that looks good is pretty sure to work well and one of the first things that anyone notices is the panel on front of the cabinet. You can add much to the general appearance of the panel by graining it. As most of us use Bakelite, I will only refer to it, altho the same procedure is followed in graining Formica.

First square up your piece of Bakelite. Place it on a flat surface and nail two thin strips of wood at the rear and in front of the panel to secure it. Procure a piece of emery cloth or sandpaper of medium roughness and fasten it to a block of wood. In rubbing the panel care should be taken to go only in one direction; that is *straight away from you*. Also be careful to have the motion of your hand parallel to the sides of the panel.

When you have sandpapered the panel until no trace of the original surface is left; clean it off with a soft cloth. Apply a film of machine oil, and with a finer grade of emery cloth or sandpaper rub the panel until the oil disappears. A very fine finish can be had by applying another film of oil and sandpapering it down. Finish off by rubbing the panel vigorously with the soft cloth. The grain can be varied by using different grades of emery cloth.

If the above directions are carefully followed the usually cheap gloss will give way to a finish that will satisfy the most exacting amateur.

Contributed by NAT. LAUBERMAN.

**PLEASE TAKE NOTICE:**  
Owing to the Printers' strike and other unforeseen circumstances my catalogue has been delayed. All those who have sent inquiries will receive my catalogue soon after this is published.

Loose Couplers  
**ARNOLD** Control Panels  
Accessories  
and  
Hard Rubber

Send 3c stamp for literature which is sure to interest you.

J. F. ARNOLD

2082 Lexington Ave., N. Y.  
near 125th Street  
Estab. 1910.

## Radio Intelligence Bureau

Earn \$125 to \$150 per Month  
Complete Course and \$15 Pre-Practice Buzzer Set

Course prepared by a leading authority on the subject. All questions answered free after purchase of course. The entire faculty is at your command to solve your problems.

**We Design** Wireless Receiving sets; Wireless Transmitters; Underground "Bogers" installations, complete or individual instruments, at nominal cost. Build your own apparatus at one-tenth the cost. We furnish dimensions, drawings, and diagrams complete. Special Questions answered by our Query Department at 25c each. If questions involve considerable research work, etc., a special charge, not to exceed \$5.00, is made.

**RADIO INTELLIGENCE BUREAU**  
864 Roosevelt Pl., Dept. A, New Orleans, La.



### VACUUM TUBE CONTROL PANEL

Most efficient and neatest panel manufactured.

Bakelite panel, graduated dials, mounted in oak cabinet. Variable grid condenser, rheostat, and tube receptacle mounted back of panel.

May be used in any circuit.

**PRICE-less Bulb (with V.T. Base or Audiotron mounting)—\$15.00**

For Full Information write

**DAYNOR RADIO ELECTRIC COMPANY**  
Box 105 Wilkensburg, Pa.

## INDUC-TANCE WIND-IND W. SIEGERT WOOD PAT-TERNS

1250 West 97th Pl.  
CHICAGO, ILL.

Special Radio and Electrical apparatus built to order

Electrical Experimental Work

Write for Estimates—I Will Save You Money

## AMATEURS

RECEIVING OUTFITS AND INSTRUMENTS

Complete Tuning Coil Receiving Set \$4.50

Send stamp for descriptive literature

**MAYMIN RADIO MFG. CO.**  
1845 E. Twelfth Street Brooklyn, N. Y.

**Device to Supplant News Tickers**  
By G. MARCONI  
(Continued from page 399)

of the circle and thus reach far greater distances than ever before attempted. Eventually science will find a way to send wireless electric waves along an absolutely straight line. The result will be far less expenditure of power for short distances and therefore less expense involved in wireless communication. And there is nothing to prove that when direction control has been completely established we shall not be able, with a powerful sending set, to girdle the entire world with wireless waves by the pressure of a single finger on a transmitting key.

Copyright Universal Service.

**NORTH DAKOTA COLLEGE STATION REOPENED.**

Erection of the wireless station at the North Dakota agricultural college, which was discontinued three years ago by order of the war department, has been started and the station will soon be in operation.

The aerial is strung on poles erected on the engineering and power machinery buildings. With the instruments with which the station was equipped for four years before the war many records were made in long distance reception. Former service men who received radio training in the field artillery and signal corps branches of the army are interesting themselves in the reconstruction of the station.

**HOUSTON AMATEUR COMMUNICATES WITH AEROPLANE**

According to a statement made here recently by Lieut. H. C. Rodd, radio operator on the NC-4, Clifford W. Vick, a Houston, Tex., amateur and wireless operator holds the record for having established the longest distance communication with the hydro-airplane of any amateur operator.

The plane was about two hundred miles from Vick's station when Lieut. Rodd first picked up Vick's signals. He did not reply at once, but thinking it might be a call from an airplane attempting to locate them, answered the call and established communication.

He is confident that he could establish communication at a much longer distance, as the signals were as clear as any professional radio operator's, and will attempt to do so when the NC-4 returns to Mobile.

# NEW MOTORS

FACTORY GUARANTEED - ALL SIZES - IN ORIGINAL BOXES

## Your Opportunity

To Buy New Guaranteed Electrical Apparatus of Standard Manufacture.

| Single Phase Motors                                            | Charging Generators                                                | Polyphase Motors                                                             | Battery Charging Outfits                                               |
|----------------------------------------------------------------|--------------------------------------------------------------------|------------------------------------------------------------------------------|------------------------------------------------------------------------|
| 110-220 volts, A. C., 60 cycle, 1800 R. P. M. with pulley      | Suitable for all lighting Battery Charging and Power Requirements. | 2 and 3 phase, A. C., 240 v. 60 c. 1750 RPM., complete with base and pulley. | To operate on A. C., 60 cycle, single phase voltage as specified.      |
| 1/4 H. P., 110 volts, induction, full load start - \$24.50     | 3 volts, 10 amp. \$16.50                                           | 1/2 H. P. - \$42.50                                                          | 110 volts, A. C., 100 watt, 24 volts, without switchboard \$40.00      |
| 1/2 H. P., 110-220 volts, induction, full load start - \$38.50 | 15 volts, 10 amp. \$21.00                                          | 1 H. P. - \$59.50                                                            | 110 volts, A. C., 150 watts, 30 volts, with switchboard \$68.50        |
| 1/2 H. P., 110-220 volts, repulsion, for compressor \$46.50    | 48 volts, 6 amp. \$24.50                                           | 2 H. P. - \$72.50                                                            | 110-220 volts, A. C., 250 watts, 24 volts, without switchboard \$75.00 |
| 1 H. P., 110-220 volts, repulsion, with sliding base - \$67.50 | 110 v, 2 1/2 amp. \$24.50                                          | 3 H. P. - \$84.50                                                            | 220 volts, A. C., 300 watts, 30 volts, without switchboard \$85.00     |
| 2 H. P., 110-220 volts, repulsion, sliding base \$108.50       | 48 volts, 12 amp. \$38.50                                          | 5 H. P. - \$102.50                                                           | 110 volts, A. C., 375 watts, 36 volts, without switchboard \$85.00     |
| 3 H. P., 110-220 volts, repulsion, sliding base \$124.50       | 110 volts, 5 amp. \$38.50                                          | 1 H. P., high speed, 3600 R. P. M., 220 v. 2 phase only - \$36.50            | 220 volts, A. C., 500 watts, 48 volts, with switchboard \$110.00       |
| 5 H. P., 110-220 volts, repulsion, sliding base \$164.50       | 48 volts, 25 amp. \$58.50                                          |                                                                              | 110 volts, A. C., 750 watts, 72 volts, without switchboard \$125.00    |
|                                                                | 110 volts, 10 amp. \$58.50                                         |                                                                              |                                                                        |
|                                                                | Moving Picture Arc Generator \$85.00                               |                                                                              |                                                                        |

WRITE FOR CATALOG. BARGAINING IN MOTORS AND GENERATORS

**1/4 SPECIAL**  
110 volts  
A. C., 60 c.  
S. P., 1750 RPM.  
Complete, cord plug & pulley

**WASHING MACHINE MOTORS**  
Suitable for operating Small Cans, Pressure, Coffee Grinders, Bottle Washers, Etc. Reg. Value \$22.50

**\$19.75 EACH**

**MONEY BACK GUARANTEE** 25% deposit required on all orders. Balance C. O. D. by Express. Sight draft with Bill of Lading attached by freight.

**SHIPPING TERMS:** MANUFACTURER'S DISTRIBUTER

**CHAS. H. JOHNSTON, Box 16, West End, Pittsburgh, Pa.**

**The Latest Audion Control Cabinet**

Here is a compact and highly efficient unit that may be used with any and all receiving circuits.

The

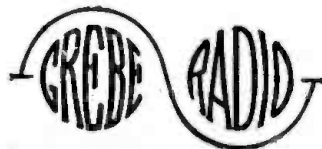

**Audion Control Cabinet Type RORH**



Price  
**\$17.00**  
Without Tube

contains the grid condenser, grid leak, filament rheostat and two 20-volt dry batteries. Socket accommodates the standard 4-prong tube.

There are binding posts for secondary, tickler, phones and filament battery. Direct and simple connections may be made to all types of receivers. Free bulletin R-117 describes this unit. Complete catalogue 10 cents.

**A. H. GREBE & CO. Inc., 72 Van Wyck Blvd., Richmond Hill, N. Y.**

# THE NEW YORK ELECTRICAL SCHOOL

**THE N. Y. ELECTRICAL SCHOOL** is the pioneer and premier school of the "Learn by Doing" method. When you have completed this Course you shall be fully qualified to handle ALL branches of Electrical Industry. The equipment of this School is unequalled and up-to-the-minute. No preparation needed to become a "learner" in this school. You can start to learn on any day of any week throughout the whole year. Send for catalogue.

**OPEN ALL SUMMER**

**NEW YORK ELECTRICAL SCHOOL**  
20-31 West 17th St. New York City

You benefit by mentioning the "Radio Amateur News" when writing to advertisers.



# 3 Inch Dial Indicator FOR SALE

No. 66 Dial Only  
75c Postpaid

No. 67 Dial with  
Bakelite Knob  
\$1.30 Postpaid

AT ALL

**Radisco Agencies**

AND BY

**A. H. CORWIN & CO.**  
4 West Park St. Newark, N. J.

## Burgess "B" Batteries

THREE  
SIZES

15 CELLS  
22½ VOLTS



BURGESS "B" BATTERIES proved so successful in Government apparatus that they are being used by progressive amateurs.

They are now available for general use. For full information write to

**Burgess Battery Company**  
Harris Trust Building CHICAGO

## ATTENTION AMATEURS

You may want to purchase a coil, a transformer, a pair of phones, a battery or one of the many pieces of apparatus necessary to properly operate your set. What do you do? You write for catalogues—the result is you have a mass of data and just can't make up your mind what to buy and who to buy it from. Our advice is DON'T BUY IT until you secure some expert's opinion and the piece of apparatus just suited to your needs.

Because we are partial to no particular manufacturer of wireless apparatus and because years of study and sales has enabled us to select wireless products with discrimination, we offer you absolutely without charge, the benefit of our EXPERT INFORMATION BUREAU which is maintained solely for the purpose of guiding the experimenter in the choice of apparatus which will, in our expert opinion, serve him best. Of course we sell apparatus and those again our knowledge manifests itself because we carry the products of over 60 of the leading manufacturers of American made apparatus—therefore you are assured that what you buy is the attainment of modern efficiency in apparatus production. We wish to strongly emphasize the fact that whether you buy of us or not we want to help you in your problems and the cost to you is but a two cent stamp. Write today for our catalogue.

**National Radio Supply Co., "The Nation's Clearing House"**  
Dept. 107, 14th and U Streets, WASHINGTON, D. C.

## WIRELESS AMATEURS, DEALERS AND MANUFACTURERS!

Have You Seen The  
"DEPENDABLE"

Line of Radio Instruments and Complete Sets?

We manufacture a large line of **DEPENDABLE** apparatus—not the cheap mail order variety, yet our prices are low. Tuners, Couplers, Detectors, Fixed and Variable Condensers, Loading Coils, etc.; also Binding Posts, Switch Points, Switch Levers, etc., etc.

Send for New Catalog No. 9 to our New York office,  
19 Park Place, New York City.

**DORON BROS. ELECTRICAL CO.** HAMILTON, OHIO.

## New System for the Reception of Undamp't Waves

(Continued from page 408)

that the amplitude of the beats will vary from a maximum of  $L + I$  to a minimum of the difference between  $L$  and  $I$ . Suppose that  $L$  is greater than  $I$ . Then the average beat current, when rectified, will be proportional to

$$[(L + I) - (L - I)] / 2 = I.$$

Consequently, we can say that when the local current is greater than the incoming current, the signal strength will be proportional to the amplitude of the incoming signals. A nearly continuous-wave station would consequently drown a distant station. If, however, the amplitude of the local oscillations is made less than that of the incoming waves, the beat amplitude will vary from  $L + I$  to  $I - L$ . The average rectified current would therefore be

$$[(L + I) - (I - L)] / 2 = L.$$

In other words, unless the local oscillations are weaker than the incoming signals, the signal strength is proportional to the amplitude of the local current. Consequently, a very high-power station would not give any louder signals than a weak distant station. This effect is decidedly useful sometimes to prevent excessive interference.

These theoretical observations are fully borne out in practise, and many interesting facts may be deduced from circuits of the type described here. To determine the frequency at which circuits A or B may be oscillating, it is useful to use one of the various types of heterodyning wavemeters which have been devised.—Paper read before the Wireless Society of London. Abstracted.

## BORDEAUX WIRELESS STATION.

The new wireless station to be erected at Croix d'Hins near Bordeaux will have a sending radius of 12,500 miles. It will be one of the most powerful wireless stations in the world, with five times the strength of the Eiffel Tower, three times that of Lyons and twice that of Naum. The station will have a capacity of 72,000 words daily and will reach all the French colonies throughout the world.

## WIRELESS IN BORNEO.

Borneo, which ranks as the third biggest island in the world, obtained her wireless service during the war. The story of the installation is very well worth the telling, not only because it is part of the world's record in industrial achievement at this dramatic time, but also because of the racial variety of the local labor employed. The Rajah of Sarawak had recognized the necessity of a wireless establishment in his dominions even before the war. The submarine piracies only strengthened his resolve and accelerated its accomplishment. Kuching, the capital, was chosen as the site of one and the principal station. Others were to be erected at Meri, at Sibü, and at Simunjan. At Kuching the population is mostly Chinese, while Sibü has a Dyak population. Malay labor—untrained—was used for the erection of the masts at Kuching, Meri, Sibü, and Simunjan. The Dyaks, who have a great reputation for work in the jungle, cleared the ground for the sites. The Tamil Indians executed the ballastings and the concreting of the foundations while the Chinese erected the buildings of stone and wood. The four stations were erected between May, 1916, and June, 1917, by the Compagnie Générale de Radiotélégraphie Française; and, considering both general conditions and local difficulties it was undoubtedly an achievement.

**The Armstrong Super-Autodyne Amplifier**

(Continued from page 405)

for obtaining resonance, after which it should not have to be changed. The amplifier coupling resistances may be Lavite sistance of extremely low distributed capacity or carbon rod resistances of the correct value. If the carbon rod resistances are used they should be clampd tightly for contact, as this resistance should not vary. Fig. 6 is a photograph of one of the first complete Armstrong amplifiers built in Mr. Armstrong's Paris laboratory. This amplifier was built for use with a loop. The cabinet shown in Fig. 7 contains the frequency changing system or heterodyne, including the rectifier. The cabinet shown in Fig. 8 contains the radio frequency amplifier and the last detector.

In the next issue, the author will give detailed constructional data on a more efficient type of Armstrong amplifier. Hints on setting up the apparatus and the detection of troubles and their remedies will also be taken up.

**The Experimenter in Australia**

(Continued from page 419)

dence from the operator of the vessel. Australia boasts a very fine specimen of iron pyrites which gives marvelous results. Of course, those of us who have valves use them, but honestly I found the old E. I. Co.'s audion properly studied. "humored" and carefully adjusted to a suitable "hookup," equal to anything I have ever used.

Americans and Australians have something in common. Cannot we form some organization such as a "Pacific Union Radio Association" that would keep us in constant touch with each other? *It's up to you, Mr. Editor.* I would always be glad to give any assistance this way, as would scores of others with me.

We have watched with interest the way you have taken up the case for the amateur experimenter, and only a strong combination will succeed in extinguishing the attitude of monopolists and officious authority, who would have war time measures always applying to anything they could not properly understand themselves.

Has the fact been overlooked in America the same as here, that our wireless telegraphic units were formed and maintained by the individual efforts of experimenters who answered the nation's call when needed, and by their own attained knowledge instructed others? Would this have been possible had a government monopoly existed? No!

F. C. JONES.

180 Edgecliffe Road, Woollahra, Sydney, New South Wales.

**NEW AUTOMATIC WIRELESS STATION.**

The Navy Department intends the erection of an automatic wireless station at Miami, Florida, and at Jupiter for sending out radiograms by a new process to ships passing the coast, according to information from Seventh district headquarters at Key West.

By the use of the new apparatus a ship at sea would know by the length of the wave the distance from the shore and thus avoid the dangerous reefs along this coast. A naval officer from Key West is here to arrange details. Each plant will cost about \$8,000.

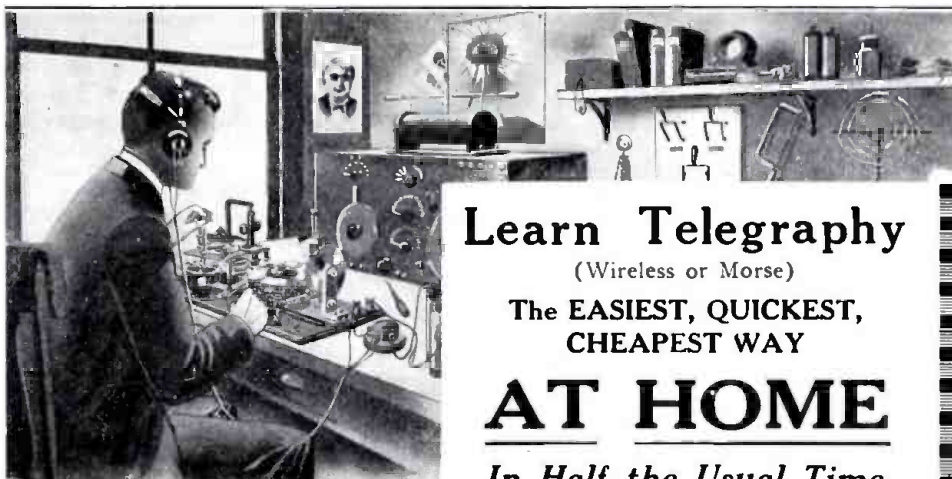

**Learn Telegraphy**

(Wireless or Morse)

The **EASIEST, QUICKEST, CHEAPEST WAY**

**AT HOME**

*In Half the Usual Time*

**WITH THE OMNIGRAPH**

*"Just Listen—The Omnigraph will do the teaching"*

The Omnigraph is an *Automatic* Transmitter that teaches you both the Wireless and Morse Codes, at home, without any expense except the cost of the machine itself. Merely connect to battery and your Buzzer, or Buzzer and Head Phones, and the Omnigraph will send unlimited messages by the hour, *at any speed* you desire.

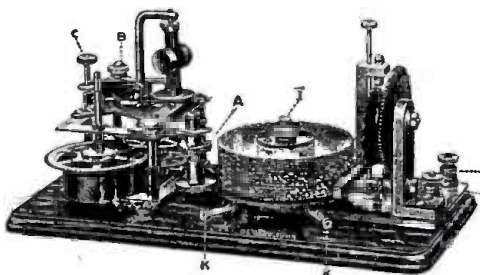

**USED BY THE U. S. GOVERNMENT**

The Omnigraph is used by the Government in testing all applicants applying for a Radio License. It is also used extensively by the large Universities, Colleges and Telegraph Schools throughout the Country for teaching Wireless and Morse. Hundreds of the Army's skilled operators who served during the war learned with the Omnigraph.

**Let The OMNIGRAPH Teach You Wireless**

For a few dollars you can have a complete outfit that will make you an experienced operator in the shortest possible time. No hard, laborious work—just learn by listening. The Omnigraph is adjustable so you can start receiving messages slowly, gradually increasing the speed as you become proficient.

You'll be surprised how quickly you will attain speed. Even if you are already an operator the Omnigraph will help you. It will make you more proficient, more accurate and more confident. Thousands of Omnigraphs are in use to-day and thousands of operators owe their success to them.

**Write for Free Catalog**

Send for a catalog to-day, showing the 3 different models, \$12.00 to \$28.00. Every Omnigraph is sold with the absolute guarantee that you must be satisfied or your money back for the asking. Mail the coupon to-day—the catalog will come to you by return mail.

**The Omnigraph Mfg. Co.**

39 F Cortlandt Street, New York City

The Omnigraph Mfg. Co.,  
39 F Cortlandt St.,  
New York City.

Gentlemen—

As per your ad in Radio Amateur News please mail me your free catalog of Omnigraphs.

Name .....

Address .....

City..... State.....

**SPECIAL SALE!**

We have on hand 2,000 Carbon Grain Transmitters as per photograph. They are first-



Reduced Photograph of Transmitter showing nickel plated case and Hard Rubber Mouthpiece



**\$1.00 ONLY**

Postage extra.

Ship. Weight, 2 lbs.

Diameter, 3 1/2 ins.

class instruments and may be used for all kind of experiments, especially for wireless telephone sets, where a heavy current is to be passed through. Slightly used, but in perfect working order. Money refunded if not satisfied. A real bargain. Order one or more today.

**THE ELECTRO IMPORTING CO., 231 Fulton St., NEW YORK**

# !! WANTED !!

## I K. W. Transmitter and Receiver

COMPLETE. Built of the very best materials THAT can be used for high school.

WHEN answering this ad, remember we only want the very best for the least money possible. Nothing considered unless blue prints and full explanations of material and workings are given.

NO JUNK WANTED

The American Pharmacy, Inc.  
Newport News, Va.

### RADIO SERVICE STANDARD V.T. RECEPTACLES

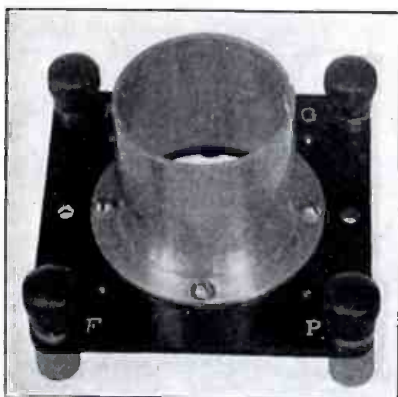

TYPE S2

- Type S1 Single Tube (similar to S3)....\$1.20
- Type S2 Single Tube (as illustrated).... 1.75
- Type S3 Double Tube (as illustrated).... 2.75
- Type S4 Triple Tube (as illustrated).... 3.75

You will appreciate owning a Radio Service V.T. Receptacle. Bulletin describing Radio Service Products sent on request. If your dealer does not carry Radio Service goods order direct and send dealer's name and address.

RADIO SERVICE & MFG. CO.

LYNBROOK, L. I.

NEW YORK

The original receptacle with a machined bakelite base. The socket is spun from sheet aluminum, making it extremely light and durable. Contact springs are of phosphor bronze. All metal parts, with the exception of aluminum sockets, are nickle-plated. Terminals are marked for the proper connections.

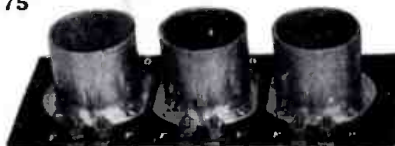
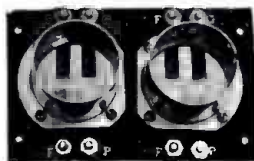

### A New Type of Condenser for Selective Tuning

(Continued from page 414)

plates and the switch arm are connected together by the metallic washers on the shaft, and are connected to the outside circuit at the proper time by means of the switch arm and contact ring. The three rotary plates set 180 degrees opposite to the nine are connected to the outside circuit thru the connector on the base of the condenser. No dimensions are shown in Fig. 3, as these are best left to the discretion of the builder. The number of rotary and stationary plates selected is arbitrary, but the rotary plates should be divided in the ratio of 3 to 1 to get the best tuning.

The tuning curve of this condenser is shown in Fig. 2. For purposes of comparison, curves of condensers of standard type having 12 and 9 rotating plates, and the curve of a square law condenser of maximum capacity equal to the capacity of the nine plate condenser are also shown. Note that the slope of curve (d) is less at its steepest point than the slope of any one of the other curves at any point. One reason for this is that the capacity increase in the condenser of curve (d) is distributed over 360 degrees of rotation, as against 180 degrees for the others. This of course means that the condenser of curve (d) will give finer adjustment, or more selective tuning than either of the other semi-circular plate condensers or the square law condenser, and it is better than the square law condenser mechanically, because it takes up less room. Curve (a) represents what would be the tuning curve of the condenser in curve (d) if the plates were arranged all on one side of the rotor. Curve (b) represents the tuning of the nine plate rotor of the condenser of curve (d) with the three compensating plates removed, while curve (d) is the actual curve of the condenser as detailed in Fig. 3.

It is rather difficult to convert a Murdock condenser into one of this type, because of the fact that all the plates are soldered into position. The only way to do it is to drill and tap the end of the rotor and thread an insulated extension shaft into it. Then by building up 3 or 4 stationary plates on the end of the soldered ones the condenser can be made to work, but it makes the whole rather cumbersome and is likely to prove unsatisfactory. Another disadvantage in using a Murdock is that the capacity in the zero position is very high, nearly .0001 m.f., and this may be enough to make the tuning curve discontinuous at the point where the large section of plates is cut in. In other types of semi-circular plate condensers this zero position capacity is negligible when added to the capacity of the small section of plates in their maximum position, and will not produce unevenness in the tuning.

Condensers of the type herein described are very good for use in cabinet sets designed to cover a wide range of wavelengths, for example from 200 to 12,000 meters. When the experimenter builds sets like this he usually wants the low wavelength adjustments fine enough for regenerative work, and at the same time wants the condenser to be large enough to work well on long wave undamped signals. This is one of the few condensers that fulfills both of these requirements satisfactorily.

A wireless telephone conversation over a 2,000 mile stretch of sea was recently carried on by E. T. Fisk, managing director of Amalgamated Wireless, Ltd., who while on the steamer Bombala communicated with his home in London by means of an experimental telephone set installed upon the vessel.

### LEARN WIRELESS

TEL. BAY BAY 5964

Splendid opportunities now in the Merchant Marine. Big salaries. All graduates GUARANTEED good positions by one of the largest Wireless Telegraph Companies operating hundreds of ships to all parts of the world. REMEMBER: We are the OLDEST, LARGEST and BEST EQUIPPED school of its kind in New England, and have THOUSANDS of satisfied graduates to our credit. THIS SPEAKS FOR ITSELF. Day and Evening classes. Advanced classes in Radio Theory and code. Start any Monday.



EASTERN RADIO INSTITUTE

699 Boylston St. Boston, Mass.

RADIO



Our prospectus for the asking

MONEY for YOU Add to your Salary—Make extra Pin Money Start a lucrative business of your own.

Spend an hour each day taking subscriptions for the "Radio Amateur News." We'll pay you well and you'll enjoy the work. Write for full particulars. Circulation Dept., RADIO AMATEUR NEWS, 233 Fulton St., N. Y. City.

You benefit by mentioning the "Radio Amateur News" when writing to advertisers.



# LICENSED BY DE FOREST AUDIOTRON

## The Original Tubular Vacuum Amplifier

The AudioTron Vacuum Tube is now manufactured and sold as a genuine audion licensed under DeForest Patents Nos. 841387 and 879532 to be used only for amplification in radio communication and only for experimental and amateur purposes and only in audio frequency circuits.

The AudioTron has a double filament of special thorium tungsten and the operating life is over 2,000 hours. No special socket is required. The electrical and mechanical dimensions result in a heavy plate current and corresponding signal strength. Plate voltage under 40. Our guarantee insures satisfaction.

**PRICE \$6.00 EACH**

If your local dealer cannot supply you we will ship postpaid when cash accompanies order.

*The AudioTron Exclusive Guaranty:* Each and every AudioTron is guaranteed to arrive in good condition and to prove fully satisfactory. Replacement of unsatisfactory tubes will be made free of charge.

**AudioTron Audio-Frequency Transformer \$7.00**

*Laminated closed core, two coil type.*

*DEALERS:—Write for our attractive trade Proposition.*

**AUDIOTRON SALES CO. Lick Bldg. SAN FRANCISCO, CALIF.**

## RADIO APPARATUS Distributors of all Prominent makes Largest and best stock of any house in New England

### DE FOREST HONEYCOMB WOUND INDUCTANCE COILS

| Solid Wire |            |                                        | Litz. Wire |          |        |
|------------|------------|----------------------------------------|------------|----------|--------|
| Cat. No.   | Appx. Ind. | Appx. W. L. range with .001 Var. Cond. | Price      | Cat. No. | Price  |
| L25        | .040       | 130-375                                | \$1.40     | LL25     | \$1.40 |
| L35        | .075       | 180-515                                | 1.45       | LL35     | 1.45   |
| L50        | .15        | 240-730                                | 1.52       | LL50     | 1.64   |
| L75        | .3         | 330-1030                               | 1.60       | LL75     | 1.70   |
| L100       | .6         | 450-1460                               | 1.70       | LL100    | 1.76   |
| L150       | 1.3        | 660-2200                               | 1.80       | LL150    | 2.16   |
| L200       | 2.3        | 930-2850                               | 1.90       | LL200    | 2.28   |
| L250       | 4.5        | 1300-4000                              | 2.00       | LL250    | 2.50   |
| L300       | 6.5        | 1550-4800                              | 2.10       | LL300    | 2.66   |
| L400       | 11.        | 2050-6300                              | 2.25       | LL400    | 3.10   |
| L500       | 20.        | 3000-8500                              | 2.40       | LL500    | 3.35   |
| L600       | 40.        | 4000-12000                             | 2.65       | LL600    | 3.00   |
| L750       | 65.        | 5000-15000                             | 2.80       | LL750    | 3.20   |
| L1000      | 100.       | 6200-19000                             | 3.00       | LL1000   | 3.75   |
| L1250      | 125.       | 7000-21000                             | 3.35       | LL1250   | 4.16   |
| L1500      | 175.       | 8200-25000                             | 3.60       | LL1500   | 4.68   |

POSTPAID TO ANY PART OF THE U. S. OR CANADA.

### DE FOREST COIL MOUNTINGS

Cat. No. LC-100—Inductance coil mounting without base, but with gears to hold three coils. \$9.00  
 Cat. No. LC-101—Same as above, but mounted on oak base, complete. 12.00  
 Cat. No. ULC-100—Same as LC-100, but mounted on unit panel. 10.00

Postpaid to any part of the U. S. or Canada.

### GREBE STANDARD DIALS WITH KNOB COMPLETE

Suitable for variometers, couplers, condensers, etc.

Cat. No. PDA 0°-100°—4 inches dia. Bakelite. \$3.00  
 Cat. No. PDB 0°-50°—4 inches dia. Bakelite. 2.50  
 Cat. No. PDD 0°-50°—3 inches dia. Bakelite. 2.25

Postpaid to any part of the U. S. or Canada.

Note:—These dials are used on all Grebe apparatus.

### EXCLUSIVE DISTRIBUTORS OF GREBE PRODUCTS IN NEW ENGLAND

Some good territory open to live dealers. Write for proposition!

REMEMBER:—All this material is carried right in stock and shipped the same day as order is received. GIVE US A TRIAL.

Send 6 cents in stamps for NEW CATALOG JUST OUT! EVERY AMATEUR should have it.

**F. D. PITTS CO., Inc. DEPT. C BOSTON, MASS.**

## Radio Diagrams and Formulae in Loose Leaf Form

The publishers of the CONSOLIDATED RADIO CALL BOOK have completed the preparation of diagrams and instructions on—

- Measurement of Capacity of a Condenser. (Substitution Method.) Calibration of a Variable Condenser. Two Diagrams and Curve...No. 1
- Measurement of Inductance of a Coil or Circuit. Two Methods—Two Diagrams...No. 2
- Measurement of Distributed Capacity of an Inductance. Diagram and Curve...No. 3
- Measurement of Fundamental Wavelength of an Antenna. Three Methods. Three Diagrams...No. 4
- Measurement of Wavelength of Distant Transmitting Station. Two Methods. Calibration of a Receiving Set. Two Diagrams...No. 5
- Measurement of Effective Antenna Capacity. Two Methods. Two Diagrams...No. 6
- Measurement of Inductance of Antenna and a Third Method of Measuring Effective Capacity of Antenna. One Diagram...No. 7
- Measurement of Antenna Resistance. Substitution Method...No. 8
- Schematic Wiring Diagram of Regenerative Audion Receiving Set Suitable for Receiving High Power Undamped Wave Stations. Connections shown are those used in most Navy and Commercial Receivers...No. 50
- Table giving the value of LC (Product of Inductance and Capacity) for wavelengths from 300 to 20,000 meters. Inductance in Microhenrys...No. 100
- Table same as above but with Inductance in centimeters...No. 101
- Schematic Wiring Diagram of Signal Corps Type SCR-68 Radio Telephone Transmitting and Receiving Set...No. 51
- Schematic Wiring Diagram of Type CW-936 (Navy Submarine Chaser) Radio Telephone and Telegraph Transmitter and Receiver...No. 52
- Schematic Diagram of Type S.E. 1100 (Navy Flying Boat) Radio Telephone and Telegraph Transmitter...No. 53

These diagrams and instructions are the most CLEAR, CONCISE, COMPREHENSIVE and CONVENIENT form of instruction that has ever been presented. They are printed on pages size 8½ x 11.

Complete Set of 14 Sheets **75c** as described, sent postpaid

CONSOLIDATED RADIO CALL BOOK CO., Inc.  
41 Park Row, New York, N. Y.

## A New Receiving System

(Continued from page 413)

By connecting the ground lead thru a variable condenser as shown in Fig. 6 to the filament post of the audion greater strength of signals is had, however the selectivity and elimination of static is dispensed with and by no means increases the efficiency. I have copied signals with this receiver when it was practically impossible to read them with the usual types of electromagnetic and other forms of coupled receivers.

Further experiments revealed that it was possible to employ this system to great advantage in the following way: If it was desired to communicate with but one certain station and it was necessary and important that the traffic get thru interference and statics, the scheme outlined in Fig. 7 can be resorted to. Here we have an antenna of but one wire 125 feet long in the plane of the transmitting station adjusted to the wavelength of the transmitting station by use of a very sensitive wavemeter. The wavemeter should be brought as far away as possible from the lead when the inductance is being excited by the buzzer and a very critical reading and adjustment found. When measurements are being taken the balancing circuit should be disconnected. The inductance thru which the antenna is grounded at its extreme end is placed in a box on a small support secure from rain. The free end of the antenna is then brought into the receiving room and connected to the balancing receiver as shown.

Advantage should certainly be taken of these timely pointers and it is highly recommended that this system be employed where selectivity and elimination of strays is desirable.

Wireless telephone communications between Miami and Bimini, in the Bahama Islands group, will be possible within two weeks, it was announced recently. The apparatus is being set up on top of one of the fashionable tourist hotels in this city.

## Improvements in Buzzer Transmitters

(Continued from page 412)

and coupling inductance described before.

The inductance coil to be used in shunting the buzzer is shown diagrammatically in Fig. 5. On a cardboard tube 5 inches in diameter, wind one layer No. 24 SCC mag-

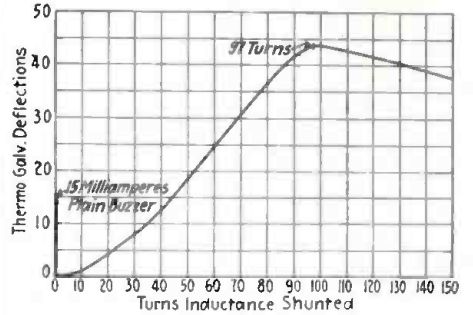

This Curve Shows Readily the Advantage Gained by Using an Inductance Shunted Across the Buzzer.

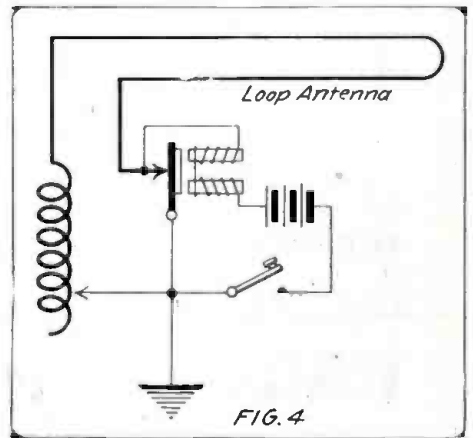

Method of Connecting the Buzzer for Use With a Loop Antenna.

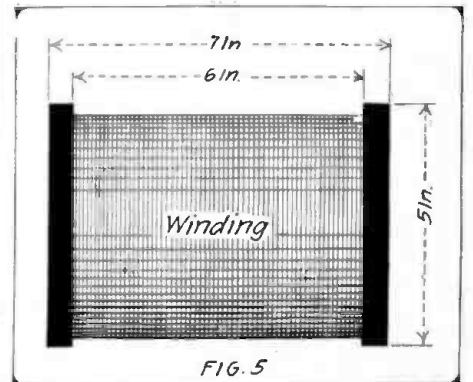

Showing the Dimensions of the Inductance Used in the Buzzer Transmitter Circuit.

## AMERICAN ELECTRO TECHNICAL APPLIANCE COMPANY

235 FULTON STREET

NEW YORK CITY

FOR THE AMATEUR, we have a full line of very interesting and suitable parts and sets, all of the best manufacture and sold at lowest prices.

Mail orders will receive prompt attention, WE HAVE THE GOODS. Our Catalog has been delayed on account of the printers strike, those who have sent for it will receive same as soon as it comes to our hands.

Storage and "B" Batteries We Have at Special Prices

Switch Points, Variometers, Loose Couplers, Tuners, Detectors, Condensers, Army Head Bands, Brandes Superior Phones, Blinding Posts, Levers, Lever Knobs, Bakelite and Hard Rubber for Panels, cut to order. Amplifying Transformers, Spark Coils, Rotary Spark Gaps, Small Motors, Wire, all kinds. Our Hard Drawn Copper is best for Aerials, Insulators, Lightning Switches, Small Switches, Panel Sets for sending and Receiving, De Forest Type Time Signal Sets, \$27.00.

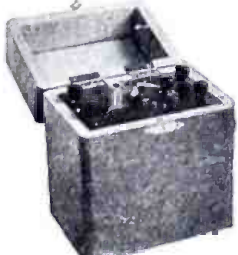

Receiving Sets \$6.00



20c Postpaid

## Wilcox Panel Switches

Why they are "The Best"

KNOBs of genuine hard rubber, highly polished. Better than moulded composition in appearance and insulating qualities.  
SHAFTS of brass with large smooth bearing surfaces. Better than steel or threaded shafts.  
LEVERS of spring brass, edgewise contact type, securely attached and highly polished.  
PANEL BUSHINGS accurately turned from brass.  
ADJUSTABLE TENSION a special feature on WILCOX switches obtained by means of an adjustable bow spring.  
UNIFORM APPEARANCE throughout a complete line of switches, knobs, etc.  
OUR LOOSE LEAF CATALOG SENT FOR 5c.  
RELIABLE DEALERS WANTED.

## Wilcox Variometer Parts

make it easy to "build your own" variometers, regenerative receivers, etc. The parts are correctly designed for an efficient and easily constructed instrument suitable for panel mounting if desired.  
SET NO. 1 contains stator (two parts) rotor and winding form carefully turned from hardwood. POSTPAID \$2.50  
SET NO. 2 contains all parts for the variometer including the above and hard rubber knob and scale, shaft, binding posts, wire and instructions for assembling. POSTPAID \$5.00

THE WILCOX LABORATORIES  
LANSING DEPT. 1 MICHIGAN

net wire for a length of six inches; bringing out taps every half inch. Greater selectivity can be had by providing a slider, and even better is a large number of taps.

The buzzer employed in this connection was an E. I. Co. Hi-tone Buzzer, which has a very high note and maintains same for a considerable length of time without the necessary readjustments experienced with other types of buzzers.

This type of transmitter should be employed thruout the country for local work to minimize the interference and trouble with amateur regulations which are bound to follow the use of powerful transmitters for such work.

You benefit by mentioning the "Radio Amateur News" when writing to advertisers.

**PROPOSED STATION AT NOME, ALASKA**

Possibilities of direct wireless between Nome, Alaska, and the mouth of the Anadir River, in Siberia, are being investigated by agents of the Postoffice Department, according to a member of the Alaskan Legislature. The Alaska bureau of the Chamber of Commerce is informed that direct wireless communication and direct steamship service between the two points will open a big field for trade.

There is a powerful wireless station at Anadir which has been in communication with Nome on various occasions.

**THE STAVANGER WIRELESS STATION**

The Stavanger wireless station, completed in 1917, was at once taken over by the United States Government and will be released—when the treaty is ratified. Erected at a cost of over 2,000,000 kroner, the Stavanger station will connect the smallest hamlet in Norway with the United States via Chatham, near Boston. Once in operation, the people of Norway can get into communication with their friends in this country for 25 cents a word.

**PACENT ELECTRIC COMPANY**

INCORPORATED

150 Nassau Street

New York

We are builders and specialists in electrical, radio and laboratory equipment suitable for amateur, experimental, research and communicating purposes and are therefore in a position to serve electrical jobbers, operators, amateurs and other interested persons to the best advantage.

You are invited to visit our show rooms which are always complete with the latest equipment; all designed by the best known engineers in the field and includes Genuine Dubilier Mica Condensers, Standard VT batteries, Grebe correctly designed receiving equipment, imported Seibt variable air condensers, Rawson ultra-sensitive instruments, vacuum tubes, standard radio laboratory apparatus, etc.

A. H. GREBE & CO.  
DUBILIER CONDENSER CO.  
RAWSON ELECTRICAL INSTRUMENT CO.

RICHTER & BRYNE.  
IMPORTED SEIBT CONDENSERS.  
VACUUM TUBE APPARATUS.

AND OTHERS.

**PACENT ELECTRIC COMPANY, Inc.**

Telephone Beekman 5810

150 Nassau Street

New York



**CONTRARY to RUMORS**

*Spread by a Competitor*

The Radio Distributing Co. is still manufacturing their unmounted universal wound Inductances, and will continue to supply their agents these very efficient coils.

That the RADISCO COILS are superior to any similar type of inductances is the opinion of several well known radio men who have received signals from very remote stations.

The RADIO DISTRIBUTING COMPANY will assure all purchasers that they will experience no inconvenience by reason of any action now pending or to be started by reason of patent on coils purchased. These coils are in stock at all RADISCO AGENTS.

RADISCO AGENTS carry only apparatus of proven merit. Look for the RADISCO trademark on all coils you buy and be sure of getting efficient apparatus.

Below are listed a few of the reliable firms who carry the Universal Wound Inductances and are our Agents for all standard radio apparatus of merit, including our now famous Better "B" Battery.

*Communicate your wants to them.*

- |                                                                                     |                                                                                      |                                                                                                        |                                                                                                                 |
|-------------------------------------------------------------------------------------|--------------------------------------------------------------------------------------|--------------------------------------------------------------------------------------------------------|-----------------------------------------------------------------------------------------------------------------|
| <b>ALBANY, N. Y.</b><br>E. L. Long,<br>21 Magnolia Terrace                          | <b>BRONX, NEW YORK CITY</b><br>Amateur Wireless Equipment Co.,<br>1390 Prospect Ave. | <b>NEWARK, N. J.</b><br>A. H. Corwin & Co.,<br>4 West Park Street.                                     | <b>PITTSBURG, PA.</b><br>Radio Electric Co.,<br>4614 Henry Street,                                              |
| <b>ATLANTIC CITY, N. J.</b><br>Independent Radio Supply,<br>118 Sp. New Jersey Ave. | <b>CHICAGO, ILL.</b><br>Chicago Radio Laboratories,<br>1316 Carmen Ave.              | <b>NEW ORLEANS, LA.</b><br>L. A. Rose,<br>4323 Magnolia Street.                                        | <b>SCRANTON, PA.</b><br>Shotton Radio Mfg. Co.,<br>P. O. Box 3<br>Also 8 Kingsbury St.,<br>Jamestown, New York. |
| <b>BIENVILLE, QUEBEC, CAN.</b><br>Canadian Radio Mfg. Co.                           | <b>HAMPTON, N. H.</b><br>De Lancey Felch & Co.                                       | <b>NEWCASTLE, PA.</b><br>Penn Wireless Mfg. Co.<br>507 Florence Avenue.                                | <b>SPRINGFIELD, MASS.</b><br>Electric Service Co.,<br>585 Armory Street.                                        |
| <b>BOSTON, MASS.</b><br>Atlantic Radio Co.,<br>34 Batterymarch St.                  | <b>LOS ANGELES, CAL.</b><br>The Wireless Shop,<br>511 W. Washington St.              | <b>PHILADELPHIA, PA.</b><br>Philadelphia School of<br>Wireless Telegraphy<br>Broad and Cherry Streets. | <b>TORONTO, ONT., CAN.</b><br>The Vimy Supply Co.,<br>585 College Street.                                       |
| <b>BROOKLYN, N. Y.</b><br>Kelly & Phillips Electric<br>Co.,<br>312 Flatbush Ave.    | <b>McKEESPORT, PA.</b><br>K. & L. Electric Co.,<br>427 Olive Street                  | <b>PROVIDENCE, R. I.</b><br>Rhode Island Elec. Equip.<br>Co.,<br>45 Washington Street.                 | <b>WASHINGTON, D. C.</b><br>National Radio Supply Co.,<br>1405 U Street, N. W.                                  |

If none of the above agencies are in your vicinity, communicate with

**RADIO DISTRIBUTING COMPANY, NEWARK, NEW JERSEY**

*You benefit by mentioning the "Radio Amateur News" when writing to advertisers.*

# Mesco Radio Buzzer

With Shunt Resistance—  
U. S. Navy and U. S. Army  
Standard.

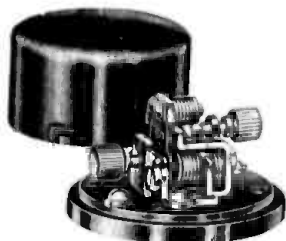

The Radio Officers of the NC planes, after testing all other buzzers, decided to use the "Mesco" on their radio equipment. The R-34 was equipped with two of them.

Why? Because of its reliability and constancy in operation; greater output efficiency; ease of adjustment; unaffected by extreme variations in weather conditions; exposed wire eliminated.

Sparking is almost entirely eliminated, so that the energy lost in light and heat in the operation of other buzzers is here conserved and radiated in the form of oscillating energy.

This buzzer maintains a constant note and is recommended as an exciter for checking wave-meters where pure note and ample energy are required.

List No. 55. Mesco Radio Buzzer. Price...\$2.05

We carry a very large and complete line of standard wireless apparatus and solicit your inquiries. Wireless experts in all of our stores.

## M-10 Wireless MESCO Manual M-10

About March 15th we will have ready for distribution a new Manual and Catalog of standard radio material illustrating and describing in detail the various instruments used in connection with the transmission and reception of wireless messages. No expense has been spared to make this Wireless Manual complete and up-to-date in every way so as to be of assistance not only to the amateur, but also to the professional user and experimenter in the most fascinating of all modern arts.

The size of the Manual will be 5 1/2" x 9" and will contain approximately 160 pages.

If interested send in your name and address and a copy will be sent to you as soon as issued.

### Manhattan Electrical Supply Co., Inc

New York: Chicago: St. Louis:  
17 Park Place 114 So. Wells St. 1106 Pine St.  
San Francisco: 604 Mission St.



## The ORIGINAL AUDIOTRON ADAPTOR

Consists of a standard 4 prong base with appropriately placed brass pillars to accommodate five leads. Practical and convenient.

**\$1.75 EACH Postpaid**  
Pat. Applied For

New "VT" Socket, \$1.00  
Postpaid

One look convinces you our

**Paragon Filament Rheostat** is the best. The 6 ohm non-oxidizing resistance, permits fine adjustment on 4 or 6 volts. Cast in heat-proof Condensite 3/4" dia. for back or front mounting.

**\$1.75 Each, Postpaid**

Have you found out yet that block batteries are impractical and rather costly for 'trons?

Our 45-volt VARIABLE "B" BATTERY complete, in wooden case with set of jiffy connectors at the price of a 22 1/2-volt block battery. \$3.50, plus postage.

NEW CONSOLIDATED RADIO CALL BOOK (2nd) \$1.00 EACH

**RADIO EQUIPMENT CO.**  
630 WASHINGTON ST. BOSTON, MASS

## UNIVERSAL SYSTEM RADIO APPARATUS

Efficient Equipment for all purposes  
Damped and Continuous Waves  
Send stamp for catalogue

UNIVERSAL RADIO MANUFACTURING CORP.  
Dept. W., Elmira, N. Y.

READ THE CLASSIFIED ADVERTISEMENTS ON PAGES 454-455

## They All Come Back

(Continued from page 417)

tents awakened my interest, and I was soon deep in an article.

"Why," said I to myself, "I can understand it. It's really interesting."

Coming out on the train I looked at some of the advertisements, and noted how the designs in detectors and couplers had changed, and also the various new instruments. Before I reached home my mind was made up, and the next day found me setting about to renovate my set and replace some of the now "obsolete" instruments. I am now up to date and hope to remain in touch with the latest, aided and abetted by the amateur's one best bet, the RADIO AMATEUR NEWS. I thank you, kind reader, for your attention.

## WIRELESS TELEPHONES FOR BORDER AIRPLANES.

In connection with the patrol of the Mexican border by airplanes, Colonel James E. Fehet, Southern Department Air Service Officer, has announced that wireless field telephone equipment, for installation on all border planes at an early date, has been ordered and is now en route.

Planes now being used on the border are equipped with high-powered radio sets, enabling messages to be received at long distance, but because they cannot carry the heavy sending set, they are unable to send out messages both ways except at a limited distance.

According to Colonel Fehet, the addition of the wireless equipment and a ground receiving set will help to relieve one of the chief difficulties of the recent punitive expeditions into Mexico—the inability to keep a constant liaison with the cavalry troops.

## NEW WIRELESS TELEPHONE CAR

The Government wireless telephone test car which has been working in Millerton, N. Y., for several weeks, has left for Washington where some extensive alterations will be made to the interior wiring of the car and to the delicate apparatus. The officers in charge of the car said upon leaving for Washington that they expect to return to Millerton shortly to continue the series of tests.

Altho no definite reports as to just what has been accomplished can be obtained from the men in charge of the car, they express themselves as being highly satisfied with what has been done and say that the tests made in the vicinity of Millerton have been the most successful made anywhere in the east.

## AIRPLANE BOMBS UNDER WIRELESS CONTROL WERE PLANNED.

The Army Air Service announced that in 1916 the German Government asked A. H. G. Fokker, of Amsterdam, to make very cheap planes for use as carriers of airplane bombs controlled by wireless.

## WIRELESS STATIONS TO BE RETURNED TO OWNERS

Wireless stations taken over by the government during the war will be returned to private ownership, announcement was made from Washington by Rear Admiral Griffin, chief of the bureau of steam engineering. He made the statement in an address before the house naval committee, adding that the ruling would go into effect when "peace was declared."

The order excepts approximately 160 coastal stations, acquired by the department during the war, which are to be retained, Admiral Griffin said.

## Three Big Bargains TELEPHONE RELAYS



Enclosed in dust-proof iron cap. Has two silver contact springs and is very sensitive. Can be used wherever a sensitive relay is required. It is adjustable and can be used for many purposes. Something that every experimenter should have. Exactly like cut.

Price..... \$1.50

Shipping weight..... 2 lbs.

## INDUCTION COILS



Standard telephone induction coils, primary 1 ohm, secondary 55 ohms. Used wherever you need a good induction coil. A cheap but very effective amplifier. Has primary and secondary and iron wire core; fibre heads. A great bargain at the price we are asking. Exactly like cut.

Price..... 50c

Shipping weight..... 1 lb.

## RESISTANCE COILS



Standard resistance, wound with German silver wire—4500 ohms. Can be used as a choke or plain resistance and has many other uses that readily suggest themselves to the experimenter.

Price..... 40c

Shipping weight..... 1 lb.

Be sure and enclose postage and insurance on the above items, otherwise we shall ship by express collect.

Send 5c for our catalogue.

## ELECTRICAL SPECIALTY CO.

Dept. R-48 So. Front St.  
Columbus, Ohio

## The Radio Engineering Company

MANUFACTURERS OF



"RADIO APPARATUS"

Reg to announce their reorganization and the opening of a show room and distribution center FOR THE SOUTH, of all standard radio apparatus.

The famous

"RECO" KEY

reduced for a short time to \$6.50. Six cents in stamps will bring our new and revised catalog now on the press.

Note New Address:

827 Madison Ave., Baltimore, Md.  
CALL 3 EM

## WIRELESS AMATEURS

Send a 2c. stamp for full description of

**The Barr Mercury-Cup Detector**

the most efficient detector in the wireless field today.

Tested by Marconi Wireless Telegraph Co. and U. S. Government.

Increases the efficiency of every wireless receiving set by making the signals clear, sharp and distinct. Instantly adjustable at a constant pressure.

**THE BARR MERCURY-CUP DETECTOR**

Dept. B. The Wyoming. Washington, D. C.

Insure your copy reaching you promptly each month. Subscribe to RADIO AMATEUR NEWS—\$2.00 a Year.

**A Step-up Condenser**

*(Continued from page 415)*

can then be screwed down tightly, compressing the plates and making a solid job of the whole thing. Connections should be taken from the washers and the whole assembled in a box as in Fig. 2.

The top drawing shows the plan of switch and handle, also the bottom and a sectional view of condenser in box. No connections are shown. The eye hole is for reading number of plates in use. All metal parts in section are shown in black. The construction of the condenser is shown in Fig. 3.

**Honeycomb Coil Mounting**

*(Continued from page 415)*

If the experimenter prefers to mount the coils on the back of the panel and vary the coupling by means of hard rubber knobs on the front of the panel, the scheme shown in dotted lines on the left hand coil may be used. The hinge is normally held closed by the tension of the spring. If the knob is screwed in, it opens the hinges and decreases the coupling. If the knob is unscrewed, the spring closes the hinge and increases the coupling.

If the experimenter will wind up several different sizes of inductance coils according to the directions in the December RADIO AMATEUR NEWS, and with the aid of the mounting described above, he can increase the efficiency of his receiving station, and in addition, make the receiving set very flexible, with limits bounded only by the size and number of coils available.



"RW4," Size 12" x 9" x 6 1/2"

**MIGNON "RW4"  
UNDAMPED WAVE  
RECEPTORS**

**NO** Loose Couplers  
Loading Coils  
Variometers  
Amplifiers

Strongest, Most Distinct Signals

**IMPORTANT NOTICE**

Ernest C. Mignon, inventor of the famous disc-core undamped wave receptor, is no longer connected with the Mignon Wireless Corporation, of Elmira, N. Y., or their successors—the Universal Radio Mfg. Corp. Address all communications for Mignon apparatus to

**MIGNON MANUFACTURING CORPORATION, Newark, N. J.**

**DAMPED AND UNDAMPED WAVE  
APPARATUS FOR ALL PURPOSES**

Endorsed by Radio Department of D., L. & W.  
R. R. Co.

Write for Literature.

**MIGNON MFG. CORP.**  
**NEWARK, N. J.**



**Vacuum Tubes Repaired**

We repair the filaments and other elements in all types of vacuum tubes and guarantee them to operate equally as well as a new tube. In most cases they operate better. We produce wonderful oscillators, detectors, and amplifiers.

**MARCONI VT DE FOREST VT  
MOORHEAD TUBES WESTERN ELECTRIC**

**Repaired at Four Dollars and Fifty Cents each**

**ELECTRON RELAYS  
OSCILLAUDIONS**

**Repaired at Four Dollars each**

All Foreign-made receiving tubes repaired at Six Fifty and power tubes depending upon size.

We have purchased a large quantity of burned out Marconi Vts. and electron relays which we offer for sale at five dollars.

Remember these tubes are guaranteed good as new.

Dealers write us

**VACUUM TUBE REPAIR CO.**

**511 Perry Building**

**Oakland, Cal.**

# Are You Satisfied--



with a double-slide tuner, crystal detector, and 80-ohm phones?

If you are, don't waste your time reading this—but if you want to get the maximum range from your set, we have the instruments that will give you this range at all times. Our instruments are real professional quality.

The two step amplifier illustrated, will give the maximum amplification and has "B" Batteries included. It uses standard V. T. Tubes. Further information on request. Price without tubes, \$50.00.

## THE PRECISION EQUIPMENT CO.

Manufacturing Engineers,

2437 GILBERT AVENUE, Dept. A

CINCINNATI

# A NEW BOOK Just Off The Press!

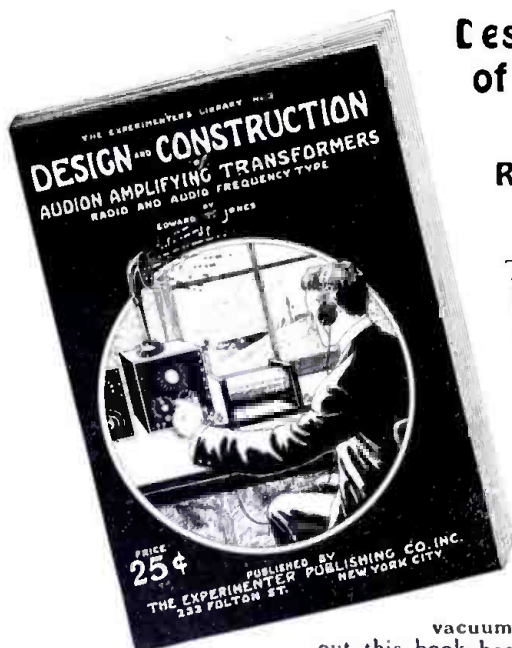

## Design and Construction of Audion Amplifying Transformers

Radio and Audio  
Frequency Type

This latest and important book by Mr. Edward T. Jones, late Associate Editor of Radio News, will be of great interest to all radio amateurs thruout the land. The transformers shown in these books have never been described in print before, and have usually been considered a manufacturer's secret.

Anyone who has several vacuum tubes cannot afford to do without this book because it will enable him to build the necessary amplifying transformers very readily. The designs are very simple and rugged, and anybody can make them without much trouble whatsoever.

Mr. Jones, the author, is a practical man, who is an experimenter himself, and knows whereof he speaks. The book is printed on good paper and has an attractive cover in two colors. Paper bound. Size, 5" x 7". Contains many illustrations, diagrams and working data necessary to build the transformers.

PRICE Postpaid, **25c**

Experimenter Publishing Co., Book Dept. 231A Fulton St., New York, N. Y.

## Tuning Coil and Loose Couplers in Panel Sets

(Continued from page 412)

difficult. The construction is shown in Fig. 1 at A. By pivoted strips of metal, the rotary motion is changed into sliding motion. The knob may be varied only thru an arc of 90 degrees. The direct method consists simply of a short rod with a rubber handle protruding from the end of the cabinet. By pushing this in or out, the coupling is varied.

Contributed by PHILIP A. WALL.

## NEW RADIOPHONE RECORD.

Wireless telephone conversation at any distance is considered a possibility of the near future by Robert F. Gowen, engineer in charge of the DeForest Radio Company, of Ossining, who conducted a series of experiments with a new wireless telephone apparatus. Employing a small aerial, a wave length of only 370 meters and one-third kilowatt of power, he claimed to have talked to Chicago and other Western cities in ordinary tones and to have been heard without difficulty.

In his experiments, which have been carried on during the last thirty days, Mr. Gowen has talked to various points in a radius of 900 miles. He explained that the receiving apparatus will also record telegraphic dots and dashes from the ordinary wireless plants.

"We have reached the development of this wireless telephone," Mr. Gowen said, "for a distance of at least 300 miles, a service that is identical with the long distance telephone."

## NEW RADIO COMPASS SYSTEM.

One of the latest wireless inventions which has been installed at the mouth of the Mississippi river, capable of transmitting to a ship its bearings will be in operation shortly, according to E. T. Jones, radio supervisor, Gulf district, United States Shipping Board, who states that there is a dire need of more radio operators for the proper operation of the different stations throughout America.

The new device consists of three receiving stations, at Burwood, Grand Isle and Passaloutre, respectively, with a master station at Burwood. A ship in a dense fog seeking its bearings makes the request and immediately the three receiving stations through a set of coils which are adjustable to determining the exact location of the ship approximately gauge the latitude and longitude and transmit it to the master station. A large board here in which the operator uses blocks in recording the degrees ascertained from each station and the conclusions of this determination is wired to the ship. The receiving stations only receive the message from the ship seeking information and transmit the findings by telegraph. The master station sends the desired information to the ship.

Such a device is now in operation in New York harbor by the navy and has proved a success. Vessels are acquainted of their bearings within a quarter of a mile. The invention was originated by Dr. Braun, who died, and it was later completed by Dr. F. A. Kolster of the Bureau of Statistics, Washington, D. C., about four years ago.

## RADIO SERVICE BETWEEN BRITISH COLUMBIA AND ORIENT PLANNED.

George E. Foster, minister of trade and commerce, is endeavoring to have the Department of Naval Service erect a high-powered wireless station on the British Columbia coast capable of communicating with the Orient. The present radius of wireless stations on the west coast is about 1,500 miles. The new station proposed would have a speaking radius of perhaps 6,000 miles.

You benefit by mentioning the "Radio Amateur News" when writing to advertisers.

**I Want to Know**

(Continued from page 430)

not tuned. For instance a receiving circuit designed to receive signals with inductance and capacity constant is termed aperiodic.

**CRYSTAL AND AUDION COMBINATION.**

(129) Robert Hawkins, Chicago, Ill., requests:

Q. 1. What is the simplest hook-up using an audion for amplification and a crystal for detecting?

A. 1. The hook-up is shown herewith.

Q. 2. Is this a practical method of reception?

A. 2. Yes; it is widely used in Europe.

**WIRELESS SET PRESENTED TO DELAWARE COLLEGE.**

The large wireless outfit that was formerly on the roof of the duPont Building, has been presented to Delaware College by the duPont Powder Company. This wireless station was established several years previous to the war and was used by the powder company for its own commercial business. It was one of the largest wireless outfits in this section of the country and had a receiving and sending radius of several hundred miles.

At the outbreak of the war the station was sealed and the apparatus partly dismantled. Since then it has been entirely dismantled. Professor Roy Keggerei, instructor in electrical engineering, on hearing that the apparatus was no longer in use, called on John J. Raskob and other officials of the duPont Company and pointed out that it would make a valuable addition to the equipment at Delaware College. The result was the announcement of it being presented to the college.

Arrangements are now being made to move the outfit to Newark. One section of the apparatus will be erected over the southern end of Harter Hall and there will be a 200-foot line extending to a pole near the temporary engineering buildings now being put up.

The station will be used by the college for experimental and other purposes in connection with the course in wireless. Previous to the war a small wireless outfit was put up over Mechanical Hall, which was used for practice purposes, but this has been out of commission since the war started.

**Radio Digest**

(Continued from page 418)

**THE CALCULATION OF THE NATURAL WAVELENGTH OF AERIALS.**

By A. MEISSNER.

The author maintains that Howe's method is too complicated and lengthy for practice and does not give accurate results. He prefers the cruder method of multiplying the length measured along the wire from earth to extremity of aerial by a coefficient found by experiment for different types of aerials. Examples: Vertical wire, 4l—4.1l; horizontal wire, 1 meter above ground, 5l; broader aerials, 5l—7l; old Nauen T aerial, 5.5l; small T (ships), 4.5—5.0l; new Nauen T (broad), 5.8l. T (breadth = l, height = 1/2 to 1/3), 9l—10l; umbrella, 6l—8l;—umbrella, low, with many wires, 8l—10l.—Abstracted from *Jahrbuch der Drahtlosen Telegraphie*.

**THE NEW AUDIO FREQUENCY AMPLIFYING TRANSFORMER**



To meet the demand for an amplifying transformer for tubes of higher impedance than the usual Marconi V. T. and for the experimenter who wishes to try various ratios of transformation, we offer the Type A-5 Laboratory Instrument. Both primary and secondary have three variations of the number of turns. The impedance between taps 1 and 2 on primary and 5 and 6 on the secondary being the same as our well known Type A-2 transformer. The maximum number of turns being between taps 1 to 4 on primary and 5 to 8 on secondary. For laboratory work, this instrument is ideal.

|                                                                           |         |
|---------------------------------------------------------------------------|---------|
| Type A2 Amplifying Transformer completely mounted .....                   | \$ 7.00 |
| Type A2 Amplifying Transformer without binding posts and panels.....      | 5.00    |
| Type A2 Amplifying Transformer without binding posts, panel or castings.. | 4.50    |
| Type A5 completely mounted.....                                           | 11.00   |
| Type A5 without binding posts, or panel.....                              | 7.50    |
| Type A5 without binding posts, panels, or supports.....                   | 7.00    |

Modulation Transformers for radio telephony work supplied at same prices as either type of amplifying transformers.

**ACME APPARATUS COMPANY,** 25 Windser Street  
Cambridge, Mass.

**A Wireless Message from Detroit**

Licensed Radio Operators are in constant demand by the Commercial Land Radio Service, Telegraph Companies, Merchant Marine, Lake and Ocean Steamship Lines, etc.

**Minimum Salary of \$125 per Month, Plus Board and Room**

is now being paid. Many operators are receiving much more than that.

Our course in Radio Telegraphy, under the direction of S. W. Edwards, U. S. Radio Inspector, offers the highest class instruction available. New, complete equipment. Day or evening classes. Opportunity to earn expenses while here.

Our day class prepares for First-Class Radio Operator's examination in three months, night class in 18 weeks.

Before deciding where to get your Radio training, write for our Free Illustrated Booklet.

**DETROIT INSTITUTE OF TECHNOLOGY**

303 Y. M. C. A. Bldg., Detroit

**STORAGE BATTERIES FOR WIRELESS SERVICE**

Batteries especially adapted for the amateur operator are described and illustrated in our new Bulletin, No. 175, copy of which will be furnished on request.

**THE ELECTRIC STORAGE BATTERY CO.**

The largest maker of storage batteries in the world

1888 PHILADELPHIA, PA. 1920  
New York Atlanta Boston Pittsburgh Chicago Washington Denver San Francisco Cleveland  
Minneapolis Kansas City Detroit Rochester  
Special Canadian Representative, Chas. E. Goad Engineering Co., Limited, Toronto and Montreal

You benefit by mentioning the "Radio Amateur News" when writing to advertisers.

**STUDENTS ART MAGAZINE**



Cartooning, Designing, Illustrating, Lettering and Chalk-Talking. Criticises amateurs' work. Full of information for artists and art students.

Satisfactory or money refunded. 20c a copy, \$1 for 6 issues. Send \$1 NOW. Thrift Stamps Taken.

G. H. Lockwood, Editor, Dept. 598, Kalamazoo, Mich.

Publishes cash art assignments, lessons and articles on

**NEW ORLEANS WIRELESS SUPPLIES AND MINERALS OF ALL DESCRIPTIONS**

**L. A. ROSE**  
4323 MAGNOLIA STREET  
NEW ORLEANS, LA.  
Send 6 Cents for Catalogue

**Club Gossip**  
(Continued from page 423)

**HUNTINGTON RADIO ASSOCIATION.**

The live wireless men of Huntington, W. Va., believing that by co-operation they could greatly improve and foster the science of radio communication in this vicinity, have formed the Huntington Radio Association. It is planned to make this association very instructive as well as interesting to those who may care to avail themselves of this opportunity to learn more about this wonderful art.

It is proposed to maintain a code practice set, which will be under the management of a thoroughly qualified man. By thus doing it is believed possible to do away with the major part of the interference, which is due to lack of familiarity with the code.

Altho up to the present time telegraphy, both damp and undamp, have received most consideration, it is planned in the near future to take up the wireless telephone of the Audio Frequency type.

Anyone desiring further information concerning the intentions and workings of the association is earnestly requested to get in touch with the president, Mr. W. D. Sanford, at 1144 Fourth Avenue, or secretary, Mr. C. H. Pinnell, 1101 Madison Avenue, Huntington, W. Va.

**THE S. H. S. RADIO CLUB.**

Snohomish is rather a small town in Western Washington, and consequently its high school is not very large and does not contain a wireless outfit. At the beginning of this school year three amateurs who were interested in wireless telegraphy got together to form a club for the purpose of studying wireless telegraphy.

We were fortunate in having at our disposal a practice set, which consisted of a buzzer in series with a battery and arranged so that four pairs of phones could be operated by any one of four keys. Every Monday night code practice meetings are held.

Business meetings are held on Wednesday of each week, during which fundamentals of radio are studied. RADIO AMATEUR NEWS plays an important part in this study. Officers recently elected were: President, Charles Bakeman; business manager, Norman Brown. The club is under the supervision of Miss Stevens, physics instructor of the school.

Plans are under way for the construction of an antenna, which is to be erected on top of the high school building. In the near future we expect to be receiving from many stations both far and near.

**RADIO INSTALLATION IN MILWAUKEE SCHOOL.**

With the purpose of supplying ex-service men as well as others with the opportunity to become first-class operators and wireless specialists, a most complete equipment of wireless apparatus combined with a thoro course under former army and navy officers, is in process of installation at the School of Engineering of Milwaukee.

The general plan of instruction as carried on in the Navy and Army is employed. There is a code instruction room where each student is supplied with a head set and key. Messages are dispatched in regular commercial order, a routine similar to that on shipboard being followed. Students are likewise given careful instruction in theory and practical instruction in wireless installation and construction.

One room is devoted entirely to operating, and here there are two complete re-

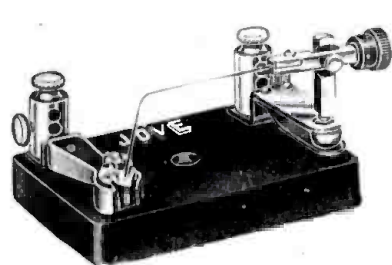

(GHEGAN PATENT)

**Bunnell INSTRUMENTS**  
Always Reliable

**JOVE DETECTOR**

Handiest, Handsomest, Best.  
Sample by Mail, \$1.80  
Tested Galena Crystal, 25c

High Grade, Inexpensive Keys, Transformers, Condensers, Spark Gaps, Receivers, etc. Send stamp for new edition 42RN Catalog.

**J. H. BUNNELL & CO., 32 Park Place, New York**

**The "BETTER QUALITY" B-BATTERIES**

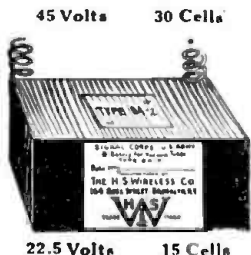

Our "Better Quality" B-Batteries are Fully Guaranteed. Note Our Low Prices as Compared to others. Low Prices but High Quality.

| CAT. No.                                                      | Voltage | Amount of Cells | Type | Kind                     | Dimensions | Average Life | List Value | Our Price |
|---------------------------------------------------------------|---------|-----------------|------|--------------------------|------------|--------------|------------|-----------|
| BB-154                                                        | 22½     | 15              | BA-2 | Signal Corps, U. S. Army | 3¼"x2"x2½" | 4 months     | \$1.50     | \$1.25    |
| Postpaid add 10c. In Canada and foreign countries add 35c.    |         |                 |      |                          |            |              |            |           |
| BB-158                                                        | 22½     | 15              | BA-2 | Signal Corps, U. S. Navy | 6½"x4"x3"  | 8 months     | 2.50       | 2.20      |
| Postpaid add 35c. In Canada and foreign countries add 50c.    |         |                 |      |                          |            |              |            |           |
| SBB-3012                                                      | 45      | 30              | BA-2 | Spl. comb. Navy and Army | 14" x8"x6" | 1 year       | 6.00       | 4.35      |
| Postpaid add 70c. In Canada and foreign countries add \$1.00. |         |                 |      |                          |            |              |            |           |

ORDER through your DEALER. If he hasn't our B-Batteries order direct from us, but send his name and address. Remember, we fully guarantee every one of our B-Batteries on a money-back basis. Write for the B-Batteries circulars.

**DEALERS: WRITE FOR PROPOSITION**

**THE H. S. WIRELESS CO., 164 Ross St., Brooklyn, N. Y.**

**4 FAMOUS BOOKS**

**Wireless Course in 20 Lessons**

By S. Gernsback, A. Lescaurou and H. W. Secor, E.E.

A course that tells you everything you can possibly want to know about "Wireless" starting off in lesson No. 1 by explaining the Principles of Electricity. The second and third lessons are devoted to magnetism, motors, generators and wiring. And then, by simple, easy stages, this wonderful Course takes you into "Wireless". The mysteries of "Wireless" are unfolded to you by the use of such simple language so skillfully used that of necessity you must understand every word. The subject is not treated superficially, however, for there is a whole lesson devoted to the Theory and Mathematics of this epoch making subject. To lend charm to the Course, the last lesson (No. 20) is devoted to a history of Wireless and the men who developed it.

Size of book is 7 x 10½ in. 160 pages, 350 illustrations, 30 tabs. Flexible cloth cover...per copy \$7.75 Stiff cloth cover...per copy 1.25 Postpaid

**Experimental Electricity Course in 20 Lessons**

By S. Gernsback and H. W. Secor, E.E.

A Course of the theory and practice of Electricity for the Experimenters. This is undoubtedly one of the most complete and comprehensive treatises of this special subject ever published. The book is written by the same authors as the famous "Wireless Course in 20 Lessons".

Every phase of experimental electricity is treated comprehensively in plain English. It is a book not only for the beginner but for every experimenter and student of Electricity. New Experiments are described and explained and nearly every application of Electricity in modern life is given in simple language.

The book contains 160 pages and more than 400 illustrations. Flexible cloth cover...per copy \$7.75 Stiff cloth cover...per copy 1.25 Postpaid

**No. 1. How to Make Wireless Sending Apparatus**

**No. 2. How to Make Wireless Receiving Apparatus**

By 20 Radio Experts

**Two Remarkable Books**

Book No. 1 contains 100 pages, size 7 x 5 in. and 88 illustrations, paper bound. Book No. 2 contains 100 pages, size 7 x 5 in. and 90 illustrations, paper bound. These two books have been written and published entirely for the wireless enthusiast who wants to make his own radio apparatus. They contain more information on how to make it than any other books we know of. Only strictly modern radio apparatus are described in these books and the illustrations and descriptions are so clear and simple that no trouble will be experienced in making the instruments.

Book No. 1—How to make Wireless Sending Apparatus...25c Book No. 2—How to make Wireless Receiving Apparatus...25c Postpaid

**THE EXPERIMENTER PUBL. CO., Book Dept., 231A Fulton St., New York**



ceiving sets, A 1 KW—500 cycle transmitter, the same as used by commercial companies, is to be installed.

The Aerial of the apparatus is on top of the six-story Administration building of the School, and its length is 100 feet. Messages have been copied from all the government high-powered stations in the country as well as from Europe.

It is the intention of the school to maintain a regular schedule by the students, each student being "on watch" one night a week from 7 to 9 P. M. The aim is to fit operators for regular commercial service, for which the demand is constantly increasing.

In the very near future it is planned to carry on experiments with radio telephones, as well as the telegraph work. The students and instructors will be glad to communicate by wireless with amateurs thruout the country during signaling periods, and also for the purpose of carrying on tests of various sorts.

Contributed by R. W. GENSKE.

**CLUB NOTICE HELPS.**

Editor *Radio Amateur News*:  
DEAR SIR:

Thanks to *Radio Amateur News* we now have several hundred members. It will perhaps be remembered that we were given a notice in the December issue of the *Radio Amateur News*, and it certainly reaches many amateurs.

This organization, unlike many others, is conducted solely by boys. Our club magazine, "The Radio Experimenter," is also put out by boys.

We wish the best of success to *Radio Amateur News*.

THE INTERSTATE RADIO CLUB OF AMERICA,  
Paris, Illinois.

**THE PHILADELPHIA AMATEUR RADIO ASSOCIATION.**

Just a few meetings ago we formed the Philadelphia Amateur Radio Association with 25 men present. At the last meeting we opened our door to 93 men. We consider this an excellent attendance record.

The speakers for the evening included R. Y. Cadimus, third and fourth district radio inspector, who offered to examine men at their homes if necessary. He also requested amateurs living in these districts who are operating receiving sets only will kindly supply his office with their names and addresses.

Several experts were present from the local navy yard, including Lieut. MacKay, who is in charge of N. A. S. He announced that they will send Q.S.T. Amateur Broadcast at 8:45 P. M. every evening.

Communications to this organization should be address to H. P. Holz, 1902 North 11th St., Philadelphia, Pa.

**RADIO FOG SIGNALLING SYSTEM.**

Experiments to ascertain the possibilities of the new radio sets devised by the Bureau of Standards for the purpose of fog signalling were made during September and October in co-operation with the Lighthouse Bureau, with which young Tupper is connected. The results of scientific laboratory studies, verified by a month of the most exhaustive practical tests in actual service, now bring the word that the light-houses may be made far more potent in their protection to ships near shore in dangerous waters by the substitution of a silent wireless message for the shriek of the mighty fog horn or the lightning-like flash of electric light. This change, according to dispatches, may be expected within a reasonable time.



**"SERVICE"**      **"QUALITY"**

**SEND US YOUR ORDERS**

**If you want prompt delivery of Grebe, DeForest, Bunnell, Acme, Murdock, Clapp-Eastham and all other standard apparatus.**

**SPECIAL NOTICE**  
The appearance of our Radio Catalog has been Delayed. Catalog will be mailed upon request at the earliest possible date.

**DOUBLEDAY - HILL ELECTRIC CO.**  
RADIO DEPT.  
719-21 Liberty Ave.      Pittsburgh, Pa.

**"SHRAMCO"**

**Reliable Wireless Apparatus  
Standardized Parts  
Raw Materials**

---

"SHRAMCO" switch points and knobs have long been standard. Our 24 page Catalog H contains complete line. Do you need KD Variables, Instrument Switches, Plugs, Jacks, Coils, "B" Batteries, Indicating Dials, Etc.? If so **SEND 5c IN STAMPS FOR COPY TODAY AND WE WILL PLACE YOUR NAME ON LIST FOR FUTURE BULLETINS WITHOUT CHARGE.**

**SHOTTON RADIO MANUFACTURING CO.**  
P. O. Box 3      SCRANTON, PENNA.  
Branch—8 Kingsbury St., JAMESTOWN, N. Y.

**RADIO APPARATUS**

De Forest, Murdock,  
Clapp Eastham,  
Distributors—Perfection Tuners  
and Condensers, Benwood Rotary  
Quenched, Honey Comb Coils, etc.  
"Radisco Agency"

The First Wireless School in America.  
Established 1911.

Day and Evening Classes.  
Correspondence Course.

**PHILADELPHIA SCHOOL OF  
WIRELESS TELEGRAPHY**  
Parkway Bldg., Broad and Cherry Sts.



P. W. Audion Panel

\$11.00 without bulb.  
Use Marconi or AudioTron Tubes.  
Parts, ready to assemble, \$8.50

**MASSACHUSETTS RADIO AND TELEGRAPH SCHOOL**  
RADIO AND TELEGRAPHY Day and Evening Classes  
18 Boylston Street      Tel. Beach 7188      Boston, Mass.

*You benefit by mentioning the "Radio Amateur News" when writing to advertisers.*

# MAGAZINE Prices Slashed



The  
Publishers  
Will Mail the  
Magazine  
Direct From  
Their Own  
Office to You.

## Millions

of magazine subscriptions expire this month! With tremendous advance of paper prices and labor it is certain that nearly all magazines will advance their subscription prices at least from 25% to 50%.

**BY ORDERING NOW YOU WILL SAVE BIG MONEY.**

In announcing these wonderful prices it is with the absolute knowledge that our readers are offered the lowest prices for standard Magazines that it is possible to obtain anywhere. Only by special arrangement with the publishers are these prices possible, but to take advantage of them, you must act quickly. Don't delay, do it now. This offer is so good that of necessity it must be limited in time. Just think of buying standard Magazines at reduced prices in time for Xmas Presents, and they certainly make ideal gifts being a constant reminder for a whole year of a considerate friend. Just glance over our wonderful prices, and see how we enable one dollar to bring you two dollars' worth, and then make up your list. When sending your order, don't forget to state where magazines are to be sent. But be sure you do it now. To-morrow means you may forget and lose this wonderful opportunity. All prices quoted are for subscribers in U. S. A. only, Canadian and Foreign subscriptions require additional postage.

**BIG SPECIAL TO "WIRELESS BUGS"**

|                                 |                                 |
|---------------------------------|---------------------------------|
| Radio Amateur News... \$2.00    | <b>Big Special to You \$11.</b> |
| Electrical Experimenter... 2.50 |                                 |
| Wireless Age... 2.00            |                                 |
| U. S. T... 1.50                 |                                 |
| Everyday Engineering... 1.50    |                                 |
| Wireless World (London) 2.75    |                                 |
| <b>\$12.25</b>                  |                                 |

|                                 |                       |
|---------------------------------|-----------------------|
| Radio Amateur News... \$2.00    | <b>Our Price 4.00</b> |
| Electrical Experimenter... 2.50 |                       |
| Regular Price... \$4.50         |                       |

|                                 |                       |
|---------------------------------|-----------------------|
| Radio Amateur News... \$2.00    | <b>Our Price 6.00</b> |
| Wireless Age... 2.00            |                       |
| Electrical Experimenter... 2.50 |                       |
| Regular Price... \$6.50         |                       |

|                              |                       |
|------------------------------|-----------------------|
| Radio Amateur News... \$2.00 | <b>Our Price 4.50</b> |
| Wireless World (London) 2.75 |                       |
| Regular Price... \$4.75      |                       |

|                              |                       |
|------------------------------|-----------------------|
| Radio Amateur News... \$2.00 | <b>Our Price 7.50</b> |
| Scientific American... 5.00  |                       |
| Everyday Engineering... 1.50 |                       |
| Regular Price... \$8.50      |                       |

|                              |                       |
|------------------------------|-----------------------|
| Radio Amateur News... \$2.00 | <b>Our Price 3.50</b> |
| Boy's Life... 2.00           |                       |
| Regular Price... \$4.00      |                       |

|                              |                       |
|------------------------------|-----------------------|
| Radio Amateur News... \$2.00 | <b>Our Price 4.50</b> |
| Popular Science... 3.00      |                       |
| Regular Price... \$5.00      |                       |

|                              |                       |
|------------------------------|-----------------------|
| Radio Amateur News... \$2.00 | <b>Our Price 3.00</b> |
| Boy's Magazine... 1.50       |                       |
| Regular Price... \$3.50      |                       |

|                                  |                       |
|----------------------------------|-----------------------|
| Radio Amateur News... \$2.00     | <b>Our Price 4.75</b> |
| Everybody's (Aft. Apr. 1 \$2.50) |                       |
| Delineator... 2.00               |                       |
| Regular Price... \$6.00          |                       |

|                                |                       |
|--------------------------------|-----------------------|
| Radio Amateur News... \$2.00   | <b>Our Price 4.75</b> |
| American Magazine... 2.00      |                       |
| Women's Home Companion... 2.00 |                       |
| Regular Price... \$6.00        |                       |

|                              |                       |
|------------------------------|-----------------------|
| Radio Amateur News... \$2.00 | <b>Our Price 5.25</b> |
| Wireless Age... 2.00         |                       |
| Illustrated World... 2.00    |                       |
| Regular Price... \$6.00      |                       |

|                              |                       |
|------------------------------|-----------------------|
| Radio Amateur News... \$2.00 | <b>Our Price 4.25</b> |
| St. Nicholas... 3.00         |                       |
| Regular Price... \$5.00      |                       |

|                              |                       |
|------------------------------|-----------------------|
| Radio Amateur News... \$2.00 | <b>Our Price 4.00</b> |
| Youth's Companion... 2.50    |                       |
| Regular Price... \$4.50      |                       |

|                              |                       |
|------------------------------|-----------------------|
| Radio Amateur News... \$2.00 | <b>Our Price 2.50</b> |
| Today's Housewife... 1.00    |                       |
| Regular Price... \$3.00      |                       |

|                                 |                       |
|---------------------------------|-----------------------|
| Radio Amateur News... \$2.00    | <b>Our Price 6.75</b> |
| Popular Science... 3.00         |                       |
| Electrical Experimenter... 2.50 |                       |
| Regular Price... \$7.50         |                       |



| Club No. | Magazine                         | Retail Price Single | Special price With (Radio Amateur News) |
|----------|----------------------------------|---------------------|-----------------------------------------|
| 60       | Adventure                        | \$3.00              | \$4.75                                  |
| 40       | American                         | 2.00                | 3.75                                    |
| 35       | Boy's Life                       | 2.00                | 3.50                                    |
| 25       | Boy's Magazine                   | 1.50                | 3.25                                    |
| 70       | Century                          | 4.00                | 5.25                                    |
| 45       | Christian Herald                 | 3.00                | 4.00                                    |
|          | Conquest (London)                | 3.75                | 5.00                                    |
|          | Cosmopolitan                     | 2.00                | 3.75                                    |
| 100      | Country Life                     | 5.00                | 6.75                                    |
| 60       | Current Opinion                  | 3.00                | 4.75                                    |
| 40       | Delineator                       | 2.00                | 3.75                                    |
| 30       | Designers                        | 1.50                | 3.25                                    |
| 40       | Everybody's (Aft. Apr. 1 \$2.50) | 2.00                | 3.75                                    |
| 35       | Etude (For Music Lovers)         | 2.00                | 3.50                                    |
| 35       | Field & Stream                   | 2.00                | 3.50                                    |
|          | Good Housekeeping                | 2.00                | 3.75                                    |
|          | Harper's Bazar                   | 4.00                | 5.75                                    |
|          | Hearst's Magazine                | 2.00                | 3.75                                    |
| 35       | Illustrated World                | 2.00                | 3.50                                    |
|          | Literary Digest                  | 4.00                | 5.75                                    |

| Club No. | Magazine               | Retail Price Single | Special price With (Radio Amateur News) |
|----------|------------------------|---------------------|-----------------------------------------|
| 60       | Metropolitan           | \$3.00              | \$4.75                                  |
| 27       | Modern Priscilla       | 1.50                | 3.00                                    |
|          | Motor                  | 3.00                | 4.75                                    |
|          | Motor Boating          | 2.00                | 3.75                                    |
|          | Munsey's Magazine      | 3.00                | 4.75                                    |
| 20       | McCall's Magazine      | 1.00                | 2.75                                    |
| 45       | McClure's Magazine     | 2.50                | 4.00                                    |
| 70       | Outing                 | 4.00                | 5.25                                    |
| 20       | Pathfinder             | 1.00                | 2.75                                    |
| 40       | Pictorial Review       | 2.00                | 3.75                                    |
| 60       | Popular Science        | 3.00                | 4.75                                    |
| 50       | St. Nicholas           | 3.00                | 4.25                                    |
| 95       | Scientific American    | 5.00                | 6.50                                    |
| 75       | Scribner's System      | 4.00                | 5.50                                    |
|          | System                 | 3.00                | 4.75                                    |
| 15       | Today's Housewife      | 1.00                | 2.50                                    |
| 35       | Wireless Age           | 2.00                | 3.50                                    |
| 40       | Woman's Home Companion | 2.00                | 3.75                                    |
| 60       | World's Work           | 4.00                | 4.75                                    |
| 50       | Youth's Companion      | 2.50                | 4.00                                    |

For computing together Magazines listed separately, add Class Numbers before title and multiply by 5, giving our price to you in dollars and cents

Write for Special Prices on ANY Publication not listed here  
We will save you money

SEND ALL ORDERS TO "CIRCULATION DEPARTMENT"  
**EXPERIMENTER PUBLISHING CO., Inc.**  
233 Fulton Street, New York City, N. Y.

You benefit by mentioning the "Radio Amateur News" when writing to advertisers.

**A Curbstone Antenna**

(Continued from page 425)

If curbstone is cement would suggest small holes being drilled every 50 feet and small lag-screws inserted to hold up wire.

Signals were copied on the typewriter from a naval station 30 miles distant, and several ships at sea came in moderately well.

The trouble with this antenna, as with most others, at the present time is the high cost of copper wire.

At present the writer has a two-wire antenna, 300 feet long and 35 feet high composed of galvanized iron wire, uninsulated, which gives good results.

For receiving purposes it is entirely satisfactory. I would suggest that a similar antenna be run thru the "back alleys" along the top of fences.

Many radio experimenters have an idea that an antenna for receiving must consist of three or four wires equally spaced on nice wooden or metal spreaders and suspended as high above the surface of the ground as possible. Far from being the case, it is to be noted that any partially insulated metallic object, clothes-lines, barbwire fences, metal roofing, house-wiring disconnected from service mains, metal drain pipes, ornamental metal fencing, old telephone lines and a thousand and one other things connected to a good receiving set will respond to signals.

Later the curbstone antenna was raised from the street 10 feet high and the intensity of signals was increased about 25 per cent.

We do not make claims that hanging a "wet wash" on a clothes-line antenna would increase the received signals 25 per cent, or that the listening operator could hear the signals gradually decrease as the sun evaporated the water from the clothes; anyway somebody might try this "idea" and make a report on the results obtained.

**RADIO MESSAGE TO AMATEURS.**

Every American naval radio station flashed a message on a recent Sunday night to test the proficiency of boy amateur wireless operators thruout the country as a contribution to the opening of the National Good Turn Week of the Boy Scouts of America. The message contained the tenth anniversary greetings of the scouts' national council and was sent at the speed of ten words a minute.

Before the war there were in the United States 175,000 wireless stations, most of which were constructed and operated by boys. With lifting of restrictions in force during the war nearly as many now are reported to be in operation. Amateur operators who received the message correctly and mailed it to national scout headquarters of New York were sent a book of radio instructions.

The call for the message was "nah," and was flashed at about 9:30 P. M., except from Chicago, where it went out at about 7:30 P. M. Wavelengths used were 1,500 meters for New York, 476 meters for the Great Lakes station, 600 meters for San Francisco, the same for New Orleans and 1,500 meters for Hampton Roads.

**AMATEUR PROGRESS.**

There can be no real progress unless amateurs keep posted on all new development in the radio art. A very effective way to do this is to secure copies of the books on various radio subjects which appear on the market from time to time. Keep posted—a good and profitable position may be awaiting you.



**DUCK'S**

New Big-264 Page No. 13 Wireless and Electrical Catalog

Will be mailed for 12c in stamps or coin which may be deducted on first order of \$1.00. Catalog not sent otherwise.

We regard this catalog as our greatest effort. It embraces everything in wireless worth while. 172 pages with no waste space devoted exclusively to wireless instruments. Your amateur friend will tell you that there never has been any wireless catalog

to take the place of catalog of this company and above all that you can absolutely depend on our goods. There is no need for any other catalog when you have this big catalog.

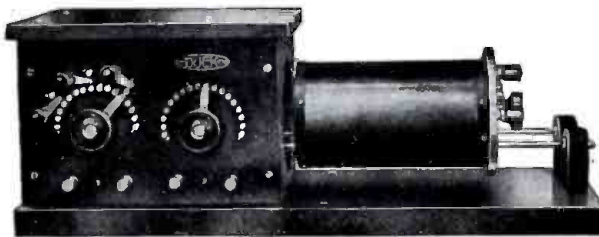

NEW MODEL 5BB. NAVY TYPE RECEIVING TRANSFORMER

A big improvement over our former model. Primary divided into four sections, with three dead end switches, greatly improving selectivity.

Secondary divided into three sections, with two dead end switches, eliminating harmonics. The change in the construction of the guide rod support makes it possible to obtain a looser coupling. It is a wonderful improvement over our old model both in performance and appearance. Only \$23.50.



OUR IMPROVED ARLINGTON RECEIVING TRANSFORMER.

The secondary on our new type Arlington is divided into three sections with two dead end switches eliminating dead end effect and harmonics and giving greater selectivity. The end support is similar to that on our Navy type permitting a looser coupling. It is a beautifully finished instrument.

Price only \$10.50.

THE WILLIAM B. DUCK CO., 230-232 Superior St., Toledo, Ohio



**INTERNATIONAL**

High Voltage—  
Direct Current  
**Motor  
Generators**

Price, \$89.00  
f.o.b. Factory—Weight, 80 lbs.

(200 milliamperes at 500 volts) with a voltage range of 200 to 500 volts. The generator is compounded to insure constant voltage under variable load. It is furnished to operate on either D.C. or A.C.; a shunt motor being supplied for D.C. and an induction motor for A.C. The generator is equipped with a commutator of 48 segments, reducing the commutator hum to a minimum.

Unit is complete with insulating coupling and mounted as illustrated on a finished base 8" x 20". Shipment can be made immediately.

The motor generator illustrated above is only one of the many newly designed radio specialties which we have ready for you. Write us for descriptive bulletins which are being issued covering all International Radio products. Address Department 22.

**International Radio Telegraph Company**  
326 BROADWAY NEW YORK CITY

**LEARN WIRELESS TELEGRAPHY**

Fascinating and Educational Work—Big Salaries—Prepare Now

The United States Shipping Board is making heavy demands upon us for Dodge-trained wireless operators. Travel all over the world, secure, free, unsurpassed living accommodations and earn a big salary.

We Also Teach Morse (Wire) Telegraphy and Railway Accounting

School established 45 years. Endorsed by wireless, railway and telegraph officials. Low rates. Students can earn living expenses while attending school. Catalog Free. Write Today.

Dodge's Telegraph and Wireless Institute

26th St.,

Valparaiso, Indiana

You benefit by mentioning the "Radio Amateur News" when writing to advertisers.

# WIRELESS MEN and AMATEURS

## The Second Edition of the Consolidated Radio Call Book

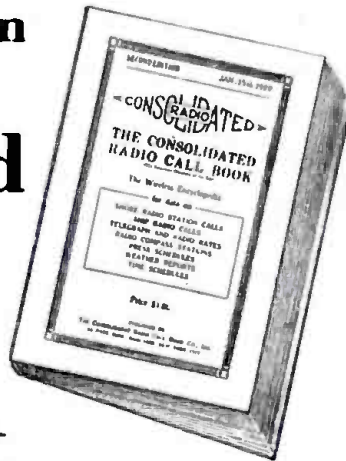

The only book in print officially listing all the amateur radio calls as issued by the Bureau of Commerce. Meets a timely and urgent necessity among radio and steamship companies, professional and amateur radio operators, and those having need of authentic and practical information on radio calls; radio, telegraph and cable rates, special signals and general radio procedure.

### All Amateur Calls Listed

In addition every vessel and land station in the world is represented and listed alphabetically, according to names of vessels or land stations, and according to call letters; Revision of American coastal stations under U. S. Naval control, and their new calls.

That new and great aid to navigation—the radio compass—is explained and is a unique feature of this publication which will be of special value to masters of merchant vessels. This book contains all calls listed in the new book to be published by the Department of Commerce.

## Price \$1.00 Prepaid

### IMPORTANT NEW Given Free with Each Copy

A Wireless Map of the World in colors is given absolutely free with each copy. This map shows the locations of all the high powered RADIO stations in the world, including the time signal stations. In addition it tells at a glance how far away any of these stations are. Of greater interest are the time zones, which enable the amateur to compute instantly the correct time for the zone in which he is located from any time signal station.

### Order Your Copy Today

Send Cash, Money Order or Check. Act quickly, as orders are pouring in and the edition will be rapidly exhausted. All orders filled in the order of their receipt and first come, first served.

**Consolidated Radio Call Book Co., Inc.**  
41 Park Row, New York City

This book also contains the advertisements of practically every leading company in the radio field.

### Use of the Vacuum Tube for Sustaining Mechanical Motions

(Continued from page 407)

A somewhat different case is that of Fig. 3, which, however, is merely a different application of the same fundamental principle. The grid and plate coils  $L_g$  and  $L_p$  are wound over iron cores having a gap in which is placed an iron disc  $R$  which is free to rotate around the axis  $XX$ . This disc is provided with a number of teeth. When set in motion, the teeth and slots of the disc alternately pass the iron core hoke of the grid coils, inducing an alternating grid emf, which in turn synchronously varies the current in the plate coils  $L_p$ . The attraction of the latter on the rotor teeth thus varies synchronously with the motion of the rotor between a maximum and minimum. With a suitable angular position of the coils  $L_g$  and  $L_p$  around the disc and proper polarity of the connections, these variations will occur at such times that the rotor is kept in continuous motion.

### RADIOPHONE VIA LIGHT BEAMS.

An instrument for telephone communication by means of rays of light, called the photophone, has been invented by Prof. A. O. Rankine, of the London Imperial College. The professor utilized electric light beams from an arc light. His words and even his breathing could be heard distinctly at a distance of eight miles.

Prof. Rankine claims that his invention could be used to produce sound from a motion picture film.

Prof. Rankine maintains that one of the chief advantages of his system is the secrecy of the conversations carried on by means of it. Although it may be said to be a system of wireless telephony, words transmitted by it cannot be picked up as in the case of wireless telegraphy, but can be heard only by the person addressed and with whom connection has been obtained. It may be added that the only disadvantage seen is that a conversation may be carried on only in a direct line.

Practically the same experiment was carried on in America twenty years ago, when Alexander Graham Bell succeeded in speaking over a distance of twenty-two yards, and then abandoned his experiments to develop the telephone.

By this system conversation is carried on through a transmitter through which light beams can be made to fluctuate according to the vibrations of the voice. Thus speaking by light rays obviates outside disturbances common to telephone and to wireless telegraphy and telephony.

At the receiving end light is thrown on a selenium element, which has the property of conducting electricity better when it is illuminated than when it is dark. It is a simple system and amounts to nothing more or less than connecting a piece of selenium with an electric battery and a receiving telephone set.

# Swear Off Tobacco

## Tobacco Habit Banished In 48 to 72 Hours

### Immediate Results

Trying to quit the tobacco habit unaided is a losing fight against heavy odds, and means a serious shock to your nervous system. So don't try it! Make the tobacco habit quit you. It will quit you if you will just take **Tobacco Redeemer** according to directions.

It doesn't make a particle of difference whether you've been a user of tobacco for a single month or 50 years, or how much you use, or in what form you use it. Whether you smoke cigars, cigarettes, pipe, chew plug or fine cut or use snuff—**Tobacco Redeemer** will positively remove all craving for tobacco in any form in from 48 to 72 hours. Your tobacco craving will begin to decrease after the very first dose—there's no long waiting for results.

**Tobacco Redeemer** contains no habit-forming drugs of any kind and is the most marvelously quick, absolutely scientific and thoroughly reliable remedy for the tobacco habit.

### Not a Substitute

**Tobacco Redeemer** is in no sense a substitute for tobacco, but is a radical, efficient treatment. After finishing the treatment you have absolutely no desire to use tobacco again or to continue the use of the remedy. It quiets the nerves, and will make you feel better in every way. If you really want to quit the tobacco habit—get rid of it so completely that when you see others using it, it will not awaken the slightest desire in you—you should at once begin a course of **Tobacco Redeemer** treatment for the habit.

### Results Absolutely Guaranteed

A single trial will convince the most skeptical. Our legal, binding, money-back guarantee goes with each full treatment. If **Tobacco Redeemer** fails to banish the tobacco habit when taken according to the plain and easy directions, your money will be cheerfully refunded upon demand.

### Let Us Send You Convincing Proof

If you're a slave of the tobacco habit and want to find a sure, quick way of quitting "for keeps" you owe it to yourself and to your family to mail the coupon at the right or send your name and address on a postal and receive our free booklet on the deadly effect of tobacco on the human system, and positive proof that **Tobacco Redeemer** will quickly free you from the habit.

**Newell Pharmacal Company**  
Dept. 675 St. Louis, Mo.

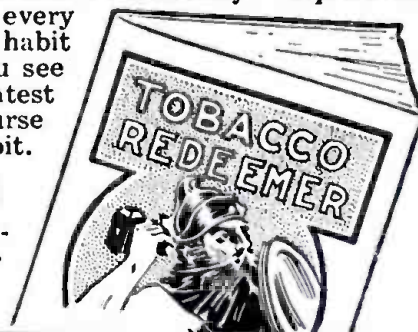

### Free Book Coupon

**NEWELL PHARMACAL CO.,**  
Dept. 675 St. Louis, Mo.

Please send, without obligating me in any way, your free booklet regarding the tobacco habit and proof that **Tobacco Redeemer** will positively free me from the tobacco habit.

Name.....

Street and No.....

Town..... State.....



Tobacco Tells on Nervous System



Tobacco Ruins Digestion



Tobacco Stunts Boy's Growth

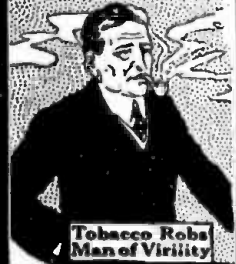

Tobacco Robs Man of Virility



Tobacco Steals from You the Pleasures, Comforts, Luxuries of Life

# OPPORTUNITY AD-LETS

Follow these advertisements every month. Reliable advertisers from all over the country offer you their most attractive specials in these columns.

Classified advertising rate three cents a word for each insertion. Ten per cent discount for 6 issues, 20 per cent discount for 12 issues. No advertisement for less than 20c accepted. Name and address must be included at the above rate. Cash should accompany all classified advertisements unless placed by an accredited advertising agency.

Objectionable or misleading advertisements not accepted. Advertisements for the April issue must reach us not later than March 10.

## THE CIRCULATION OF RADIO AMATEUR NEWS IS OVER 34,000

EXPERIMENTER PUBLISHING CO., INC., 233 Fulton Street, New York, N. Y.

### Agents Wanted.

Man or Woman, start anywhere; materials that cost 25c retail for \$5.00. Details free. Lee Dept. 5, 340 1/2 University Ave., Los Angeles, Cal.

Free Electrical and Wireless Apparatus for selling a household article that every housewife needs. Let me send you one dozen prepaid that sell at 25c a set; catalogue and full information. Beck Novelty House, 1298 Carroll St., Brooklyn, New York.

### Aviation.

100 Model Aeroplanes. Good flyers. 15c brings working drawing and prices. F. Bruland, Redford, Mich.

### Books.

Star Amateur Electrician. Pocket size 12c. Joel Tillberg, Proctor, Vermont.

For the amateur wireless man—The Radio Amateur. Marion, Illinois. Seventy-five cents per year.

Idea Exchange, an Amateur's monthly—Year \$1.00. Copy 10c. If interested in helping edit this magazine, send in your stories, poems, cartoons, etc., At Once! Carl A. Hansen, 828 Eighth Ave., Brookings, So. Dak.

Concordia Magazine contains essays, short stories, travel stories, boy scout news, editorials, current events and poetry, formulas and plans. Two years' subscription 50 cents. Concordia Magazine, 9 Water, York, Pa.

Educational—Nature laws married and engaged people should know, 50c. 150 modern house building plans and designs, \$1.00. Other books, catalogue free. Central Company, 601 Ninth Ave., New York.

Back issues of all magazines supplied by Boston Magazine Exchange, 107A Mountfort St., Boston.

Wireless Course in 20 Lessons. By S. Gernsback, A. Lescarboura and H. W. Secor, E. E. Tells you everything you want to know about "Wireless"—theory, practice and history. A clear, concise course on every phase of this subject. 160 pages—350 illustrations, tables. Flexible cloth cover 75c postpaid. Stiff cloth cover \$1.25 postpaid. Experimenter Publishing Co., Book Dept., 233 Fulton Street, New York.

Back Numbers R. A. N.—Have you missed a copy of the Radio Amateur News? Now is your chance to get it. We can furnish copies of the August, September, October, November, December and January issues at 15c each. Orders filled immediately. Experimenter Publishing Co., Book Dept., 233 Fulton Street, New York City.

Experimental Electricity Course in 20 Lessons. By S. Gernsback and H. W. Secor, E. E. A course of the theory and practice of Electricity for the Experimenter. Every phase of experimental electricity is treated comprehensively in plain English. New experiments are described and explained and nearly every application of Electricity in modern life is given. 160 pages—400 illustrations. Flexible cloth cover, 75c postpaid. Stiff cloth cover \$1.25 postpaid. Experimenter Publishing Co., Book Dept., 233 Fulton Street, New York.

### Business Opportunities.

Raise Giant Rabbits for Me. I furnish breeders cheap, and buy all you raise at 30 to 60c per pound alive. Hundreds make big money. Send 10c for Breeder's Instruction Book, contract price list, etc. Y. Frank Cross, 6407 Ridge, St. Louis, Mo.

Luminous Paint makes watches, clocks, etc. visible in the dark; electric light switch plates, pull chains, visible at night; easily applied. Large bottle 50c (coin) prepaid. Send 1c stamp for circular. Illuminant Co., 744L No. Lockwood, Chicago.

Raise Silver Foxes. Exceptional opportunity. Large profits. Easy to raise. Will not interfere with your regular occupation if desired. Particulars free. C. T. Dryz, 5244 75 S. Maplewood Ave., Chicago.

\$30 per 100 paid for names and addresses. Particulars free. Victor-King Co., 36 Bromfield St., Boston, Mass.

### Song Poems.

Song-Writers Manual & Guide Sent Free! Contains valuable instructions and advice. Submit song-poems for examination. We will furnish music, copyright and facilitate publication or sale. Knickerbocker Studios, 311 Galety Bldg., New York.

### Help Wanted.

Earn \$25 Weekly, spare time, writing for newspapers, magazines. Experience unnecessary; details free. Press Syndicate, 5665, St. Louis, Mo.

Be a Mirror Expert. \$3-\$10 a day; spare time home at first; no capital; we train, start you making and silvering mirrors French method. Free prospectus. W. R. Derr, Pres. 579 Decatur Street, Brooklyn, N. Y.

Secret Service Operatives and Detectives are in demand. Earn big money. Travel everywhere. Fascinating work. Learn this profession by home study. Particulars free. American School of Criminology, Dept. R, Detroit, Mich.

### Salesmen Wanted.

Young Americas. Sells every family, 100% up. A future for U. Permanent. Sample 30c. Dept. J. Box 527, Stanley, Wis.

### Health.

My-T-Fine Scalp Cleaner. A new hair wash. Perfect dandruff eradicator. Cleans the scalp, strengthens the roots, preserves the hair; absolutely harmless; 25 cents postpaid. My-T-Fine Scalp Cleaner, No. 564 Central Avenue, Brooklyn, N. Y. Agents wanted.

Pyorrhea (Rigg's Disease—Bleeding or Swollen Gums). H. E. Kely, D.D.S., M.D., pyorrhea specialist for 15 years, has developed a successful home treatment for pyorrhea. Purifying, healing, preventative. Full month's treatment, \$1 postpaid. Or, write for free booklet. Pyorem Mfg. Co., 439 Seventh St., Brooklyn, N. Y.

Tobacco or Snuff Habit Cured or no pay; \$1 if cured. Remedy sent on trial. Superba Co., SB, Baltimore, Md.

### Miscellaneous.

Three Master Keys: Open average locks, 50c set. Lattime, Locksmith, R78 Dexter St., Medford, Mass.

### Motor Engines and Dynamos.

Complete set of drawings of the Liberty 12 Engine. A United States Standardized Aircraft Engine. Giving all views with number of parts, names of parts and weights of parts. Mail \$1.00, Dept. A, Ocean Publishing Co., 25 W. 42nd St., New York City.

### New Correspondents.

Earn \$25 Weekly, spare time, writing for newspapers, magazines. Experience unnecessary; details free. Press Syndicate, 566 St. Louis, Mo.

### Printing.

3000 two color labels \$1.25. Irvin J. Wolf, Station E, Philadelphia.

1,000 Newmarket Bond letterheads, prepaid, \$2.50. Envelopes, \$2.75. Echo Printery, Wauwatosa, Wis.

Fifty classy name cards printed in gold, 50c. Durso, Dept. 50, 25 Mulberry, New York City.

Embossed note sheets and envelopes, hundred each, dollar eighty. Daniels Co., Pittston, Pa.

### Postcards.

24 fun creating cards, 10c silver. Durso, Dept. 50, Mulberry, New York City.

Beautiful art post cards, photographs; state wants; samples 25c. Art Studio, 826 Calhoun St., Ft. Wayne, Ind.

### Tricks, Puzzles and Games.

150 parodies on latest songs, 10c. Charles Dynes, Winchester, Ind.

### Electrical Supplies and Appliances.

Auction bargain, 8000 complete soldering outfits at 38c cash (money order). Soldering iron alone worth more. Harry Fuchs, 1805 Pitkin Ave., Brooklyn, N. Y.

Experimental Electricity Course in 20 Lessons. By S. Gernsback and H. W. Secor, E. E. A course of the theory and practice of electricity for the experimenter. Every phase of experimental electricity is treated comprehensively in plain English. New Experiments are described and explained and nearly every application of electricity in modern life is given. 160 pages—400 illustrations. Flexible cloth cover, 75c postpaid. Stiff cloth cover, \$1.25 postpaid. Experimenter Publishing Co., Book Dept., 233 Fulton Street, New York.

### Patent Attorneys.

Milions spent annually for ideas! Hundreds now wanted! Patent yours and profit! Write today for free books—tell how to protect yourself, how to invent, ideas wanted, how we help you sell, etc. 301 Patent Dept., American Industries, Inc., Washington, D. C.

### For Inventors.

Brooklyn Experimental and Tool Co., 462 Ridgewood Avenue, Brooklyn, specializes in small money-making articles. Send your ideas to us for free advice as to practicability and estimate for model and patent. All communications strictly confidential.

Inventors—We do experimental, model, tool, die and jig work; light manufacturing. Miller & O'Brien Mfg. Co., North Saint Paul, Minn.

Inventors: Models, dies, tools. 28 years' experience, work guaranteed, lowest price. Manufacturing of specialties our hobby. Peerless Die & Tool Co., 121 Opera Place, D. B. Cincinnati, Ohio.

### For Advertisers.

Money? Jacobus Art Ads. make small space pay big dividends, price \$5.00. Write today. Jacobus Service, 1073 Sanford Ave., Irvington, N. J.

### For Men.

Safety Razor blades resharpened, double edge 35c per dozen; single edge, 25c per dozen; we pay postage. White Star Safety Razor Sharpening Co., 611 Chestnut St., Northside, Pittsburgh.

Detectives Earn Big Money. Travel; great demand; experience unnecessary; we train you; write for free particulars. American Detective System, 1068 Broadway, N. Y.

### Rubber Stamps.

Rubber Stamps made to order. McCadden Company, Zanesville, Ohio.

### Song Writers.

Song Writers: You cannot afford to miss our proposition. Reference, any bank or first-class sheet music house. Warner C. Williams & Co., Dept. R, Indianapolis, Ind.

### Stamps and Coins.

Coins, medals, paper money, antique firearms, Indian relics, curios, stamps. Catalogue free. Antique Shop, 33a South 18th, Philadelphia.

25 Mixed Stamps with my 50 a/c approvals, 5c. Burchnell, Monroeville, Ind.

"Best One Cent Approvals in America". F. P. Hand, 117 So. 60th St., Philadelphia, Pa.

200 all different stamps, including Bosnia, Bavaria, China, Guatemala, Bulgaria, Bohemia, Poland, Turkey, etc., and Dime Stamp Album, only one to a customer, all for 25c. Our approval sheets contain Bargains priced at 1c to 5c Net. 150 different U. S. Postage and Civil War Revenues for only 75c. Indiana Stamp Co., Dept. E., Indianapolis, Ind.

100 Different Stamps, 12c.; 200, 27c. Michaels, 5600 Prairie, Chicago.

Have you seen The Stamp Herald? Finest monthly stamp paper published. Subscription 50c a year, 3 months' trial for 10c. Stamp Herald Publishing Co., Dept. E., Indianapolis, Ind.

100 foreign stamps, 15c. 100 U. S. stamps, 25c. Veale, Box 1362, Detroit, Michigan.

### Stammering.

St-Stu-t-t-tering and Stammering cured at home. Instructive booklet free. Walter McDonnell, 121 Potomac Bank Bldg., Washington, D. C.

### Scenery for Hire.

Collapsible Scenery for all plays. Amelia Grain, Philadelphia, Pa.

### Telegraphy.

Telegraphy (both Morse and Wireless) and railway accounting taught thoroughly and quickly. Big salaries now paid. Great opportunities. Oldest and Largest School, Est. 45 years. Catalog free. Dodges Institute, 25th St., Valparaiso, Ind.

### Personal.

The Salesman Wins. Thousands of positions open. We teach traveling salesmanship by mail and guarantee offer of position or refund tuition. For interesting particulars, address Kansas Vocational Bureau, Miltonvale, Kan.

You benefit by mentioning the "Radio Amateur News" when writing to advertisers.

**Wireless.**

**Attention Amateurs!** A handsome detector stand; fibre base with felt bottom; aluminum standards, with binding posts, complete, 75c postpaid; you will want one; send today. The Skyline Radio Co., Canon City, Colo.

**Rheostat, new panel design,** only seventy five cents. "B" Battery switch complete sixty cents. Knob only, fifty cents. Switch lever, ten cents. Other bargains. Satisfaction guaranteed. Literature free. Watch for specials. Write, Stratton Electric Company, 215 Federal Street, Greenfield, Mass.

**Arlington tested silicon or galena,** 15 cents. Philadelphia Radio Supply, 5714 Hazel Ave., Philadelphia.

**Wireless amateurs** you can build things better from working drawings. Send \$1.00 today for set of blueprints of an amateur wireless receiving set. Northwestern Blueprint Co., Portland, Oregon, Box 331.

**The Audion.** Its early history and development, Electron Theory and Trigger Action. Compiled by a Chief Electrician Radio, who was stationed at the Naval Radio School as instructor for two years, written by an old amateur for the amateurs, in words that they can understand. Also blueprint diagrams for hook-ups for Receiving Damped Signals, using both air exhausted and gas bulbs. Receiving undamped signals and regenerative circuits. Two step, Amplifier using same (A) and (B) Batteries for both steps. Wireless Telephony with Power Bulb. Working Blue Prints on how to build a "One to One" transformer for use with Audion Amplifier. All for Two Dollars. Address T. O. McKenzie, 104 Warburton Ave., Yonkers, N. Y.

**Leumite** the new ultra-sensitive detector crystal. Marvelous for fine adjustment and clearness or signals. Used by the U. S. Navy. Generous crystal 25c, coin. Leumas Laboratories, 1306 Park Ave., New York City.

**Complete Receiving Sets,** \$7 and up. With 1,000-ohm receiver, tested mineral; guaranteed. Bulletin for stamp. Jenkins, 923 Purchase St., New Bedford, Mass.

**For Sale:** nickel plated switch contact points 1/4 inch x 1/4 inch. Price 36c per doz. Switch arm and knob 1/4 inches diameter. 3/4 high equipped with any length arm required. All kinds of panels and cabinets made to order. Write for prices. M. Bovard, Grove City, Pa.

**Aerial Wire,** seven strands No. 22 solid copper. 100% radiation, shipping weight 15 lbs. per 1000 feet. Sent postage. No. C. O. D.'s; immediate delivery; this grade worth \$15.00 per thousand. For a limited time am selling at 1 cent per foot. \$9.00 per thousand. Lee A. Bates, 8 Moen St., Worcester, Massachusetts, Call 1 G Y.

**Audio frequency amplifying transformers,** \$4.00 P. P. One transformer with one Western Vt-1 gives an energy amplification of 450 times. Adams & Hilliard, 5410 Fulton St., Chicago, Ill.

**Audiotron Detector-Amplifier** double filament \$6.00. Audiotron Detector Panels, \$15.00. Audiotron B Battery 45 volts guaranteed one year. \$6.00. Nebraska Radio Company, Omaha, Nebraska, 918 North 40th Street.

**Going out of business—**Will sell cheap. 2500 meter mahogany finish panel receiving set \$20.00. 2000 meter mahogany finish loose-coupler \$10.00. 1800 meter loose-coupler \$5.00. Murdock tuner \$2.00, Murdock 2000 ohm phones \$3.75, Murdock 3000 ohm phones \$4.75, Murdock oscillation transformer \$3.75, Murdock Aerial Switch \$2.75, one pair slightly used, Stromberg-Carlson 2000 ohm phones \$8.00. Hinz Electrical Co., 234 Palmer Ave., Syracuse, N. Y.

**Just off the Press.** Design and Construction of Audion Amplifying Transformers (Radio and Audio-Frequency Types) By Edward T. Jones, late Associate Editor Radio Amateur News. The transformers shown in this book have never been described in print before and have usually been considered a manufacturer's secret. The designs are very rugged and simple. A book that every radio "bug" should have. Written so you will understand every word. Price 25c postpaid. Experimenter Publishing Co., Book Dept., 231-A Fulton Street, New York City.

**How to Make Wireless Receiving Apparatus.** 100 pages, 90 illustrations. Only strictly modern radio apparatus are described in this book and the illustrations and descriptions are so clear and simple that no trouble will be experienced in making the instruments. Paper covered, 25c postpaid. Experimenter Publishing Co., Book Dept., 233 Fulton St., New York City.

**How to Make Wireless Sending Apparatus.** 100 pages, 88 illustrations. Written and published entirely for the wireless enthusiast who wants to make his own radio apparatus. Contains more information on "how to make it" than any other book we know of. Paper bound, 25c postpaid. Experimenter Publishing Co., Book Dept., 233 Fulton St., New York City.

**Wireless Course in 20 Lessons.** By S. Gernsback, A. Lescaurhoura and H. W. Secor, E. E. Tells you everything you want to know about "Wireless"—theory, practice and history. A clear, concise course on every phase of this subject. 160 pages—350 illustrations, 30 tables. Flexible cloth cover, 75c postpaid. Stiff cloth cover, \$1.25 postpaid. Experimenter Publishing Co., Book Dept., 233 Fulton St., New York.

**Exchange.**

**Buy, sell, exchange** wireless and electrical goods. Murdock, Clapp-Eastham, Thordarson, Brandes, etc. Send 10c stamps for our circulars listing new standard apparatus at less than manufacturers' prices. We have to exchange: Wireless, Electrical, Optical, Cameras, Printing Presses, Typewriters. Large list free. LaRoy Zehrbach, 30 College Ave., Hiram, Ohio.

**For Sale—**1 K. W. Mounted step up transformer \$18; not for wireless; write for description; a bargain. Victor Yann, 512 Catherine St., Syracuse, N. Y.

**Sale.** 43 Modern Electrics 1909-1916. Waldie, 21 Woodbury St., Beverly, Mass.

**Bargain:** E. I. Co. Navy type loose coupler; never used; guaranteed perfect; cost \$18.00; first \$15.00 takes it. Edward Webb, New London, O.

**Oliver Typewriter for Wireless Set.** Joe Shaw, Trout, La.

**Bargains wireless apparatus,** small bench lathe, polishing head, field glasses; fine condition, cheap. 242 Grove, Melrose, Mass.

**Sell 3x5 printing press** including font 12 pt. type, paper, etc., 5x7 plate camera (Seneca) including 10 unused plates. Or exchange for wireless apparatus. Rex Jule, Bucksport, Maine.

**For Sale cheap, wireless instruments;** will sell for \$25; send for list. Stephen Jarvis, 8 McKinley Ave., East Orange, N. J.

**For sale:** wireless course in good condition; cost \$45, sell for \$18. This includes theory, laws, etc., four test books; just the thing for the beginners. P.P. Genuine leather note book, size 5 1/2 inches with 100 sheets of paper for same; bargain \$2.50 P.P. Hockey skates, beveled edges, nickel plated, never used \$3.25 P.P. (10) Hawkins electrical guides new \$8.00, No. 6 Remington typewriter, good condition, \$14.00. Edward Spadoni, Summit, Ill.

**Exchange:** 1470 High-grade foreign and U. S. stamps, with album, for loose-coupler and detector. Lester Wertz, Temple, Penna.

**Sell Murdock 55 Phones,** 3000 ohms, \$3.50. Exchange for 43 plate variable. Clark Rice, Jr., Main Street, Baton Rouge, La.

**For Sale.**—Radioson detector and potentiometer, cost \$7.50; first \$5.00 takes them. Charles Pyne, Quarters "L" Navy Yard, N. Y.

**For Sale:** De Forest triple coil unit receiving set of ten panels complete with veriner condensers, eighteen honeycomb coils and bulb; purchased from factory November 1919; what offer F. O. B. Sidney Pearce, Box 818, Charleston, Washington.

**Combined telescope and microscope,** 12 diameters, \$3.50. No. 2, Chemcraft set, \$3.00. Steam engine 11 in high, \$1.00. Daisy air rifle 500 shot, \$1.00. Construction toys, \$14.00 worth, \$8.50. New Rogers jigsaw grinder and drill, \$6.00. Counter shaft, \$5.00. Erector motor, \$1.00. Control base, \$5.00. Meader G. Pattington, Aurora, New York.

**Sale:** Storage battery six-volt, sixty ampere-hour, absolutely new; first \$14 money-order takes it. Preece Jr., 4 Rhoda Court, St. Petersburg, Fla.

**For Sale:** Electrical and wireless apparatus. Motors, Tesla coils, spark-coil, etc. Write for price and description. Stanley Miner, Winnebago, Illinois.

**Will trade or sell,** all kinds electrical apparatus for wireless apparatus. Will sell or trade stamp collection and chemistry outfit. Carlton Kohler, 2000 Humboldt, South Minneapolis, Minnesota.

**Quick Sale:** Stromberg Carlson Telephone \$8.00, Murdock 1500 ohm Headset complete \$2.50, Murdock 80 ohm \$1.00, Ducks audible alphabet \$1.00, Century buzzer \$1.65, Fine key \$1.00. Send stamp for descriptions; would like to buy or rent an Omnigraph No. 2 and records for wireless. Ivan A. Juline, Knoxville, Iowa.

**Bargains:** Doran 3000 coupler, \$7.50; 100 ampere D. P. D. T. switch, would make two lightning switches, \$4.50; 35 ampere D. P. D. T. switch, \$1.50; lightning switch, \$2.00; Erector motor, \$1.50; small-fixed condensers, \$4.00 each. Other goods not advertised. Prepaid. Write, Johnston, 9 Rutherford, Binghamton, N. Y.

**For Sale:** Wireless instruments, send stamp for list. William Hanlon, 3800 Margaretta St., Pittsburgh, Pa.

**Rotary Converter** 110 D. C. to A. C. 1/2 H. P. Peerless machine, bargain, \$28. A. Heberlein, 768 Melrose Ave., N. Y. C.

**Wanted:** Gasoline driven cycle car; all letters answered, or a Sypher Junior car. M. Gleich, 164 Ross St., Brooklyn, N. Y.

**For Sale:** Mesco 2 inch coil, \$8.00, Electro 1/2 kilowatt transformer coil, \$6.00. Electrolytic interrupter, \$2.00 necessary to transformer. Folger Frost, Summit, New Jersey.

**For Sale:** Audion V. T. \$6.00; \$2.40 de Forest receptacle \$1.50; \$5.50 Murdock phones 3000 ohms \$4.50; also loading coil, detector; variable condenser, .0005; fixed condensers; 60 ft. aerial; telegraph set. Write for prices and description. Kenneth Easter, O'Neill & Co., Baltimore, Md.

**For Sale:** Full bakelite panel, with double filament Audio Tron bulb and "B" batteries. First \$12 money order takes. Sent prepaid. Geo. Birdsall, Hampton, Iowa.

**Exchange—(Continued)**

**Will pay cash** for a Thordarson or Packard. 1 K. W. transformer and condensers to go with transformer; also have large assortment of radio sending and receiving apparatus to trade including 3 inch coil outfit complete De Forest audion, Brandes, sporting goods, books. All letters answered. William C. Babcock, Head St., Penn Yan, N. Y.

**For Sale:** The following articles are brand new. Electro 8 volt-10 ampere dynamo direct connected to a 6 inch red devil water motor bolted to an iron base; first \$18 takes it. 2 audiotrons at \$4.00, Murdock No. 344 receiving transformer, \$5.75, Barr Mercury cup detector, \$4.00, also 4 H. P. gasoline engine in A-1 condition, \$15.00. Write for list on audion accessories. Am leaving town and must sell everything. Write for list. Wanted a cycle car. M. Gleich, 164 Ross St., Brooklyn, N. Y.

**For Sale:** Grebe Short Wave Regenerative Receiver, complete half kilowatt transmitter, cabinet receiver, telephones, variables, vacuum tubes, loading coils, large honey-comb coils and mounting, long wave coupler, variometers. (Propose of—leaving city. W. N. Durham, 1323 Pine Street, Philadelphia, Pa.)

**Exchange—**\$15 wall telephone for pair Baldwin phones or sell for \$10. Donald Berkey, 1026 Cleveland Avenue, Niagara Falls, New York.

**Sale:** Chambers Navy Coupler, \$7.50 prepaid. Armstrong, Grand View Hotel, St. Petersburg, Fla.

**Attention Experimenters—**Am compelled to sacrifice a large amount of high grade wireless and electrical apparatus including large variable condensers, audion bakelite panels, tubes, bases, knobs, tickler forms, celluloid jar storage batteries, etc. Phone, write or call. Freund, 2340 Madison St., Brooklyn, N. Y.

**\$65 Grebe CR4 like new \$50.** General Radio calibrated variable \$10. Manhattan 3 inch coil \$17. Bunnell \$4 key \$2.50. Murdock gap 75c. Murdock \$5.00 Sending condensers \$3.50 each. Murdock \$3.25 Sending Condensers \$2.75 each. Bunnell \$2.25 gap, \$1.25. Bunnell \$3.50 gap \$2.25. 1/2 inch coil \$2.00. New \$25 Murdock rotary gap \$20. Two United Wireless unmounted variables both \$6.00. Bunnell \$15.00 variable, plates touch \$6.00. \$28 Omnigraph \$20. Delivery guaranteed. Vincent Natalish, Jr., 68 West 56th St., New York City.

**PIN \$1.  
TO COUPON**

Write your name and address plainly, mail us both, and by return mail you will receive your

**Skinderviken  
Transmitter  
BUTTON**

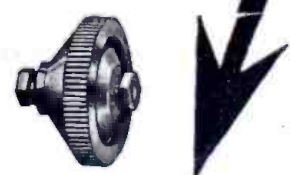

**Electro Importing Co.**  
231-A Fulton St., N. Y.

Gentlemen:—  
Enclosed please find One Dollar. Ship at once one Skinderviken Transmitter Button to

Name .....

Address .....

City .....

State .....

NAME .....

ADDRESS .....

STATE .....

ELECTRO IMPORTING COMPANY,  
231A Fulton St., New York City.

I enclose herewith 6 cents in stamps or coin for which please send me your latest Cyclopedia Catalog No. 21 containing 176 pages, 263 illustrations and diagrams, including Treatise on Wireless Telegraphy, and 20 coupons for your 160 page Free Wireless Course in 20 lessons.

R. A. N. 2-20



# FILL IN THIS COUPON FOR YOUR COPY OF

## Our New 176 Page Cyclopedia No. 21

### IT IS WAITING FOR YOU

Full size fac-simile of our catalog just as it looks when you get it

1-2 INCH THICK

WEIGHT ALMOST 1-2 POUND

263 Illustrations



# Wireless & Electrical Cyclopedia



Catalog No. 21

**The Electro Importing Co.**  
231 FULTON STREET NEW YORK

**"EVERYTHING FOR THE EXPERIMENTER"**

### A Few Interesting Things from Catalog No. 21

Treatise on Wireless Telegraphy by H. Gernsback, Editor Electrical Experimenter and Radio Amateur News—13 big pages, 3 illustrations.

The Wireless Law of 1912—all about it, what you can do and what you can't.

How to receive and send Radio messages.

How far you can send messages.

Table of wave lengths of principal U. S. & foreign Radio high power stations.

How to receive time signals by Radio.

How to construct an amateur aerial.

How to use the test buzzer.

How to join the "Radio League of America" FREE, including application blank.

How telephone receivers are wound and built, tested and magnetized, 3 pages, 2 illustrations.

Experiments with a pony telephone receiver, with 6 illustrations.

Wireless Codes: Morse, Continental, Navv.

Experiments with spark coils, 3 pages.

How to photograph electrical discharges (sparks).

All about storage batteries, how to test them, recharging, etc.

Tesla experiments, 2 pages.

How to make Selenium Cells (illustrated).

**FREE** with this wonderful cyclopedia—20 coupons for our 160 page Wireless Course in 20 lessons, 350 illustrations, 30 tables. Catalog explains how you can get this Course absolutely free.

## "THE LIVEST CATALOG IN AMERICA"

**I**N this cyclopedia you will find 116 pages all about radio. One of the greatest catalogs of its kind in print.

You will find in it dozens of wireless instruments of the famous E. I. Co. make. Remember always that this company was the **FIRST** to make and sell wireless instruments, the first wireless outfit having been placed upon the market by them in 1904. The E. I. Co. *knows how*, because it has the experience. Others imitate but cannot equal

E. I. Co. for quality and workmanship.

Other things you will find listed in this catalog: Electrolytic Interrupters, Bulldog Spark Coils, Chemical Outfits, Omni-graphs, Code Practice Sets, Telegraph Instruments, Primary Batteries, Storage Batteries, Solenoids, Hydrometers, Volt and Ammeters, Batterymeters, Electrolytic Rectifiers, Rheostats, Tesla Coils, Nickel Plating Outfits, Lighting Plants, Dynamos and Motors, Microphones, Detectiphones, Loud

Talkers, High Frequency Apparatus and supplies, Heating Pads, Electro-magnets, X-ray tubes, Telephones, Magnetos, Low Tension Transformers, Books, etc., etc.

**IN A WORD THE MOST COMPLETE CATALOG IN PRINT**

**ELECTRO IMPORTING CO.**  
231-A FULTON STREET NEW YORK, N. Y.

**"Everything for the Experimenter"**





# Every Electrical Man Wants These Books and we ship them for your inspection **FREE**

Flexible  
Covers  
—  
Handy  
Pocket-  
Size  
Volumes

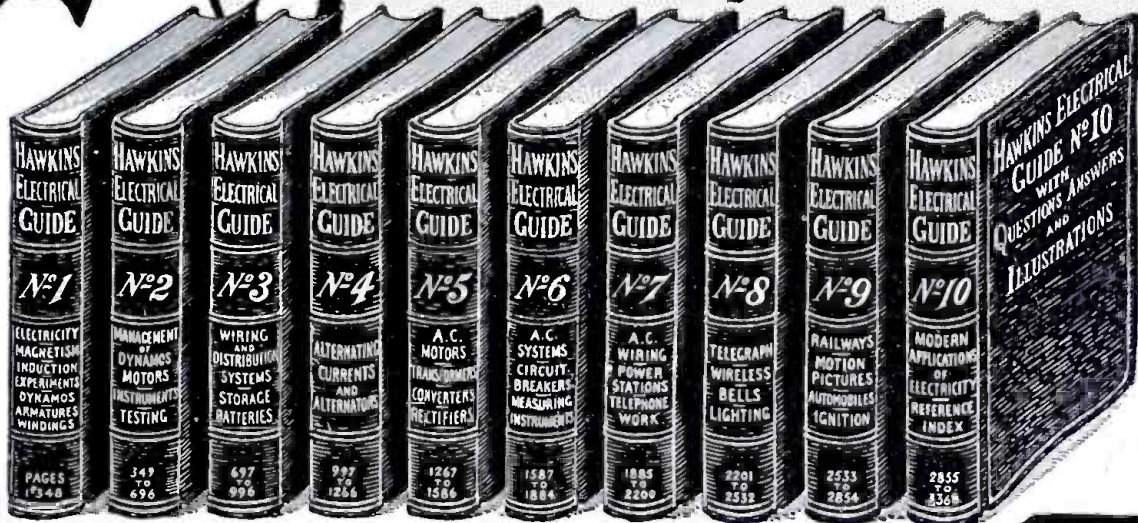

10  
Volumes  
3500  
Pages  
4700  
Pictures  
\$1 Per  
Volume  
\$1 Per  
Month

## Just what you need to know to succeed in **ELECTRICITY**

EVERY electrician, every engineer, every mechanic should know about these wonderfully helpful instructive books, which give in plain words a complete working knowledge of electrical engineering in all its phases.

You run into some new electrical problem almost every day. The information you need to help you in your every day work is in

# HAWKINS ELECTRICAL GUIDES

These books place electricity at your finger ends. They cover every imaginable subject, principle, theory, problem, trouble, and way of doing things electrically. Every subject is indexed so that you can turn right to it. They are a study course and a reference guide in one, written in plain every day language—no wasted words—only what you need to know—checked full of up-to-the-minute electrical knowledge. The guides are a complete course in electrical engineering. They will help you in every detail of the day's electrical work. You can't ask an electrical question that Hawkins Guides can't answer.

### Pocket-Size Flexible Covers

The books are small enough to slip into your coat pocket—handily bound in flexible black covers. You can carry each volume with you until you have mastered its contents. 3,500 pages of actual information and 4,700 illustrations. Once you see these books and put them into actual use you will never again want to be without them. Try it at our expense.

## SEND NO MONEY

It will cost you nothing to receive these books—to look them over—ask them all the questions you can think of—use them in your work—study them—pick up some information that will increase your earning ability. We will ship you the entire set of 10 volumes entirely FREE. This is a sign of our confidence in the guides. Pure gold does not object to being tested. Keep them for seven days and if you do not decide that you can't get along without them, return them to us and owe us nothing.

When you decide to keep them you only have to pay \$1.00 down and remit the balance of \$9.00 on the easy payment of \$1.00 a month till paid for. Use this coupon to get the books. It will pay you many times over

**THEO. AUDEL & CO.**  
72 Fifth Ave. New York, N. Y.

**SEND NO MONEY - USE THE COUPON**

### READ THIS PARTIAL LIST OF CONTENTS

- No. 1** Contains 348 pages, 388 illustrations. Electrical signs and symbols—static and current electricity—primary cells—conductors and insulators—resistance and conductivity—magnetism—induction coils—dynamo principles—classes of dynamos—armatures—windings—commutation—brushes, etc.
- No. 2** Contains 348 pages, 394 illustrations. Motor principles—armature reaction—motor starting—calculations—brake horsepower—selection and installation of dynamo and motors—galvanometers—standard cells—current measurement—resistance measurement—standard cells—current meters—watt hour meters—operation of dynamos—operation of motors, etc.
- No. 3** Contains 300 pages, 423 illustrations. Distribution systems—wires and wire calculations—inside, outside and underground wiring—sign flashers—lightning protection—rectifiers—storage battery systems, etc.
- No. 4** Contains 270 pages, 379 illustrations. Alternating current principles—alternator current diagrams—the power factor—alternator principles—alternator construction—windings, etc.
- No. 5** Contains 320 pages, 614 illustrations. A. C. Motors—synchronous and induction motor principles—A. C. commutator motors—induction motors, transformers; losses, construction, connections, tests—converters—rectifiers, etc.
- No. 6** Contains 298 pages, 472 illustrations. Alternating current systems—switching devices—circuit breakers—relays—lightning protector apparatus—regulating devices—synchronous condensers—indicating devices—meters—power factor indicators—wave form measurement—switch boards, etc.
- No. 7** Contains 316 pages, 379 illustrations. Alternating current, wiring power stations—turbines; management, selection, location, erection, testing, running, care and repair—telephones, etc.
- No. 8** Contains 332 pages, 436 illustrations. Telegraph—simultaneous telegraphy and telephony—wireless—electric bells—electric lighting—photometry, etc.
- No. 9** Contains 322 pages, 627 illustrations. Electric railways—electric locomotives—car lighting—trolley car operation—miscellaneous applications—motion pictures—gas engine ignition—automobile self-starters and lighting systems, electric vehicles, etc.
- No. 10** Contains 513 pages, 599 illustrations. Elevators—cranes—pumps—air compressors—electric heating—electric welding—soldering and brazing—industrial electrolysis—electro plating—electro-therapeutic—X-rays, etc.

A complete 126-page ready reference index of the complete library. This index has been planned to render easily accessible all the vast information contained in the 10 electrical guides. There are over 13,500 cross references. You find what you want to know instantly.

**THEO. AUDEL & CO.**  
72 Fifth Ave.  
New York, N. Y.

Please submit me for examination Hawkins Electrical Guides (price \$1 each). Ship at once, pre-paid, the 10 numbers. If satisfactory I agree to send you \$1 within seven days and to further mail you \$1 each month until paid.

Signature.....

Occupation.....

Employed by.....

Residence.....

Reference..... R.A.N. Feb.

### What Electrical Men Say Helped Him Make Good

"It is only right for me to recommend highly the Hawkins Guides, for they have been of the greatest assistance to me in placing me in my present position as Superintendent of Construction Department of one of Ohio's largest Electrical Companies. I would like to see every man have a set of Hawkins Guides."  
Geo. Knecht, Columbus, Ohio.

### In the Naval Electrical Dept.

"The Hawkins Guides are great help to me in the Naval Electrical Department, which they cover very thoroughly."  
C. J. Cornell,  
U. S. Receiving Ship, Brooklyn, N. Y.

### Superintendent

"I am now superintendent of the Dunnville Hydro-Electric Systems, and Hawkins Guides were a great help to me in holding down a responsible position."  
W. E. Swartz, Dunnville, Ontario.

### Wireless Operators

"I have worked wireless for ten years—but I wish I had these books years ago, as they have saved me a great deal of trouble."  
H. Marshall,  
Steamer M & B No. 2,  
Walkerville, Ont.

You benefit by mentioning the "Radio Amateur News" when writing to advertisers.

# Learn Wireless By Mail—In Few Weeks

**Calls Coming in Steadily, for National Radio Institute Graduates, from All Parts of the Country. Four Concerns Guarantee to Take All Operators We Can Furnish.**

Commercial Radio has arrived and many attractive positions are now open in the Commercial Land Radio Service, Merchant Marine, Railroads, Radio Supply Factories, Lake and Ocean Steamship Lines, Telegraph Companies and Aerial Mail Service. We are now receiving requests for more National Radio Institute Graduates than we can furnish.

## Salaries Up to \$350 a Month

With exceptional opportunity for promotion to Radio Mechanics, Electricians, Engineers, and Government Inspectors. No previous experience or training is necessary. You can learn Wireless the National Radio Institute way, in A Few Weeks, by mail, right in your own home. With our help you can quickly qualify for First Grade Government License and a good position paying approximately \$225 a month to start. Many of our students secure positions before completing the course, because it is based on actual practice and teaches what is needed to make a big success of Wireless work.

## Get Your Instructions from the Nation's Capital

(Our Course Is Endorsed by the United States Government Officials)

The National Radio Institute, established in 1914, was the first in America to successfully teach Wireless by Mail. It is headed by authorities who have been closely allied with government training of students. The work is under the direction of J. E. Smith, E. E., formerly director of the Radio Department, Howard University, and E. R. Haas, formerly of the Radio Division of Yale University, assisted by a competent corps of trained instructors and lecturers.

We now have hundreds of students throughout the world. Our location in the Nation's Capital, together with the standing of our officers and their wide acquaintance among government officials connected with Wireless activities, places us in position to give our students the best instructions obtainable and to be of the utmost help in assisting them to secure good paying positions.

## Travel If You Want To

If you want to travel and see the world,

go to foreign countries and increase your knowledge of world affairs, Wireless offers you the chance of a lifetime. However, you are not obliged to travel, but may secure a permanent position at one of the many Land Radio Offices, Railroads, Telegraph or Steamship Companies if preferred.

## Pay as You Learn

Our plans of payment places a wireless education within the reach of anyone who desires to learn. A small payment down on our convenient payment plan, and small following payments, enables you to earn the cost of your tuition while actually learning to be a wireless operator.

## Instruments to Every Student

In addition to five text books, one handbook—46 special Lessons and 18 Personal Examinations—we send you, while taking our course, a Standard Automatic Transmitting and Receiving Set for sending and receiving messages. These fine instruments are sent only to National Radio Institute Students.

## Free Membership in N. R. I. Relay League

Upon enrollment every student in the National Radio Institute is presented with a handsome blue and gold pin, signifying his official membership in the N. R. I. Relay League, with a rapidly growing membership throughout the world.

**FREE** In addition to our complete course in radio telegraphy, every student is given our complete course in modern radio telephony. This course comprises ten special lessons and ten personal examinations. These combined courses enable our students to fill positions requiring thorough knowledge of both radio telegraphy and modern radio telephony.

Send the following coupon today with 2c postage for our FREE book containing all particulars and special offer to students enrolling now.

**MAIL THIS COUPON TODAY**

**NATIONAL RADIO INSTITUTE**  
Department 170, 14th & U Sts. N. W.  
Washington, D. C.

I enclose 2c postage. Send me, free of charge, your booklet, "Wireless the Opportunity of Today," with full particulars regarding your famous Home Study Course and your Special FREE INSTRUMENT OFFER.

Name .....

Address .....

City ..... State .....

THE CAREY PRINTING CO. '90  
NEW YORK



MERCHANT MARINE



LAND COMMERCIAL  
RADIO



TRAIN DISPATCHING



AERIAL MAIL



AERIAL COMMERCE